

DARRAN

NOT SO square Open

price list | effective January 2016 | updated 1.11.17



NOT SO SQUARE OPEN PRICE LIST REVISIONS

DATE	PAGE	MODIFICATION	DESCRIPTION
7.20.16	ALL	Removed finish	Removed discontinued finish MGS Graystone
7.20.16	ALL	Added Finish	Added new finish MST Studio Teak
7.21.16	49	Updated SKUS	Switched SKUS 7018CA065/5818CA065
7.21.16	26	Updated SKU	60 x 30 x 1.5 was incorrectly labeled 5430, now 6030
7.21.16	50	Edited Finishes	Removed metal finishes
7.21.16	61	Edited Incorrect Price	190 COM was changed to 275 COM

TABLE OF CONTENTS

- Product index 2
- General Information 4
- Limited Lifetime Warranty 5
- Damages | Returns | Reparis 6
- Ordering Information 7
- GSA Customer Information 8
- Freight..... 9
- Features & Advantages 10
- Finishes | Specifications..... 12
- Edges | Pulls 13
- Grommets | Grommet Reference 14
- Modesty Reference | Doors | Grain Direction 15
- Drawer Dimensions | FILING Reference 16
- Electrical Features 20
- Worksurface Tops 25
- Legs 27
- Adjustable Height Desk and Units 29
- Storage Tower Kits 33
- A La Carte Kit Items 41
- End Cabinets..... 46
- Benches and Mobile Peds 49
- Shared Storage 53
- Not SO square Tables 56
- Not SO square Stools..... 57
- Bar Height Table and Bar Stools..... 58
- Overhead Storage and Privacy/Modesty Panels 61
- Fabric Privacy and Modesty Tack Panels 68
- Acrylic End Pricacy Panels 74
- Options 78

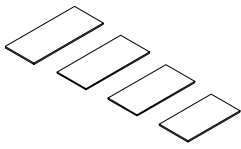

PAGE 26
WORKSURFACE TOPS

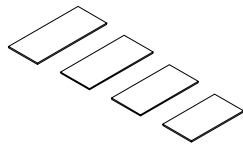

PAGE 27
WORKSURFACE TOPS

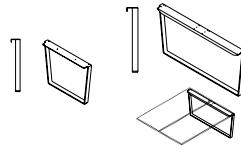

PAGE 28
LEGS

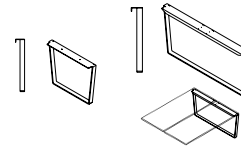

PAGE 29
LEGS

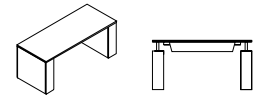

PAGE 30
ADJUSTABLE HEIGHT DESK AND
UNITS

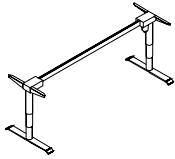

PAGE 31
ADJUSTABLE HEIGHT DESK AND
UNITS

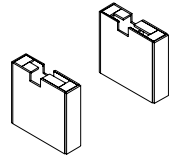

PAGE 32
ADJUSTABLE HEIGHT DESK AND
UNITS

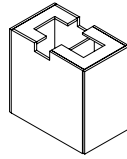

PAGE 33
ADJUSTABLE HEIGHT DESK AND
UNITS

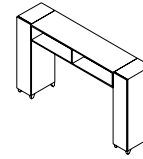

PAGE 34
STORAGE TOWER KITS - KIT #1

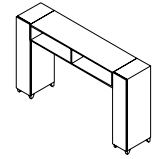

PAGE 35
STORAGE TOWER KITS - KIT #2

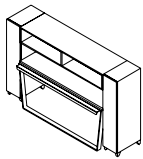

PAGE 36
STORAGE TOWER KITS - KIT #3

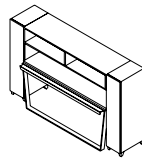

PAGE 37
STORAGE TOWER KITS - KIT #4

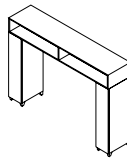

PAGE 38
STORAGE TOWER KITS - KIT #5

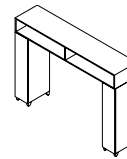

PAGE 39
STORAGE TOWER KITS - KIT #6

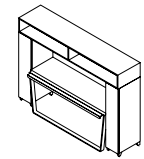

PAGE 40
STORAGE TOWER KITS - KIT #7

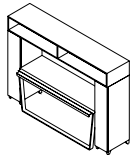

PAGE 41
STORAGE TOWER KITS - KIT #8

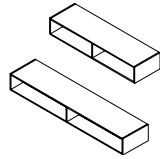

PAGE 42
A LA CARTE KIT ITEMS

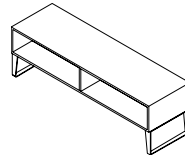

PAGE 43
OVERHEAD STORAGE AND
PRIVACY/ MODESTY PANELS

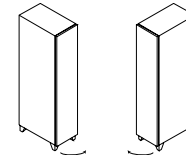

PAGE 44
A LA CARTE KIT ITEMS

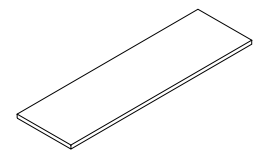

PAGE 45
A LA CARTE KIT ITEMS

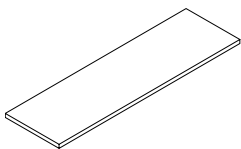

PAGE 46
A LA CARTE KIT ITEMS

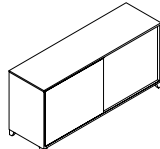

PAGE 47
END CABINETS

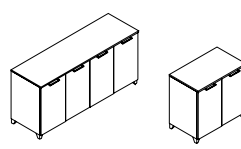

PAGE 48
END CABINETS

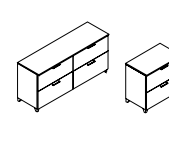

PAGE 49
END CABINETS

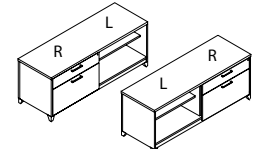

PAGE 50
BENCHES AND MOBILE PEDS

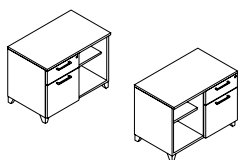

PAGE 51
BENCHES AND MOBILE PEDS

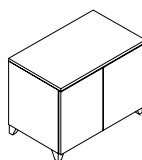

PAGE 52
BENCHES AND MOBILE PEDS

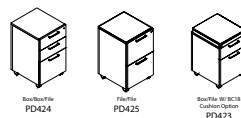

PAGE 53
BENCHES AND MOBILE PEDS

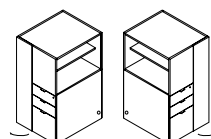

PAGE 54
SHARED STORAGE

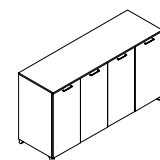

PAGE 55
SHARED STORAGE



PAGE 56
SHARED STORAGE

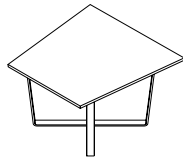

PAGE 57
NOT SO SQUARE TABLE

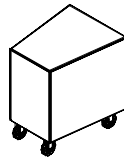

PAGE 58
NOT SO SQUARE STOOL

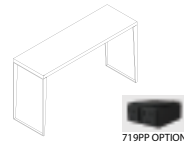

PAGE 59
BAR HEIGHT TABLE AND BAR
STOOLS



PAGE 60
BAR HEIGHT TABLE AND BAR
STOOLS

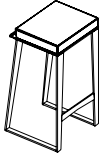

PAGE 61
BAR HEIGHT TABLE AND BAR
STOOLS

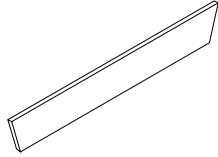

PAGE 62
OVERHEAD STORAGE AND
PRIVACY/ MODESTY PANELS

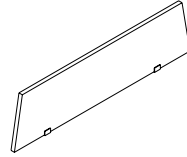

PAGE 63
FABRIC PRIVACY TACK PANELS

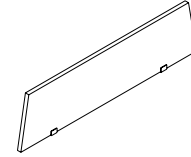

PAGE 64
FABRIC PRIVACY TACK PANELS

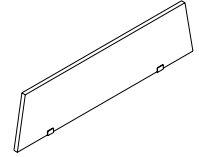

PAGE 65
FABRIC PRIVACY TACK PANELS

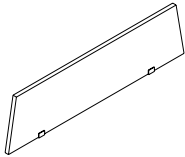

PAGE 66
FABRIC PRIVACY TACK PANELS

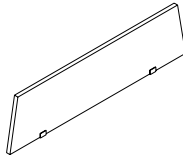

PAGE 67
FABRIC PRIVACY TACK PANELS

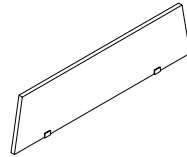

PAGE 68
FABRIC PRIVACY TACK PANELS

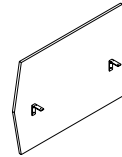

PAGE 69
FABRIC PRIVACY AND MODESTY
TACK PANELS

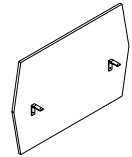

PAGE 70
FABRIC PRIVACY AND MODESTY
TACK PANELS

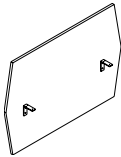

PAGE 71
FABRIC PRIVACY AND MODESTY
TACK PANELS

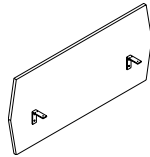

PAGE 72
FABRIC PRIVACY AND MODESTY
TACK PANELS

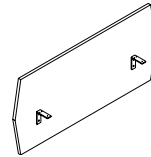

PAGE 73
FABRIC PRIVACY AND MODESTY
TACK PANELS

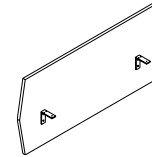

PAGE 74
FABRIC PRIVACY AND MODESTY
TACK PANELS

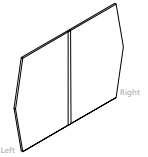

PAGE 75
LAMINATE END PRIVACY PANELS

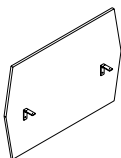

PAGE 76
ACRYLIC PRIVACY/MODESTY
PANELS

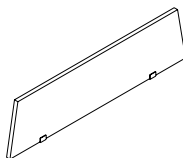

PAGE 77
ACRYLIC PRIVACY/MODESTY
PANELS

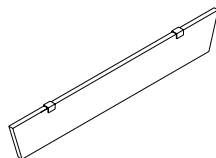

PAGE 78
ACRYLIC PRIVACY/MODESTY
PANELS

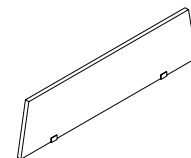

PAGE 79
ULTRACLEAR GLASS PRIVACY/
MODESTY PANELS

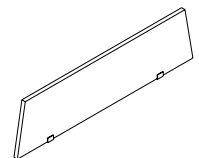

PAGE 80
ULTRACLEAR GLASS PRIVACY/
MODESTY PANELS



All DARRAN products are proudly manufactured in the U.S.A.

BUILT TO ORDER

Manufactured per order the way you want it, including modifications.

FULLY ASSEMBLED

Unless otherwise noted, all products are fully assembled and ready to use, including add-on options.

PERFORMANCE TESTED

All products are tested to ensure performance exceeds BIFMA / ANSI standards.

LIMITED LIFETIME WARRANTY

DARRAN Furniture Industries, Inc. ("DARRAN") warrants that each piece of furniture manufactured in its North Carolina Facilities will be free from defects in material and workmanship for as long as the original purchaser owns and uses the product. Subject to the limitations and exclusions herein, DARRAN, at its discretion and as the sole remedy under the DARRAN Limited Lifetime Warranty, will replace or repair a defective product or components with comparable product or components free of charge. This warranty is made only to the original purchaser from an authorized DARRAN dealer, for as long as that original purchaser owns and uses the product.

LIMITATIONS: USE / CARE

- › Warranty is limited to normal single shift use.
- › Warranty is limited to generally accepted care and maintenance of natural wood products and environments.
- › Natural wood surfaces are subject to denting, scratching, and gauging if not properly used and cared for. Warranty is subject to use and care in accordance with the use and care instructions provided in the Product Care section of this site (including, but not limited to, the care and maintenance guide downloads linked thereon), available at www.darran.com/product-care, which are incorporated herein by reference.

LIMITATIONS: MATERIALS / COMPONENTS

- › Laminates - 10 Years
- › Electrical lamps, Ballasts, Transformers - 5 Years
- › Fabrics, Pneumatic lifts, Foam - 5 Years
- › Custom products built to customers specifications - 3 Years

WARRANTY EXCLUSIONS

Damage identified as carrier or installer related.

- › Normal wear and tear of products during course of ownership.
- › Color, grain, or texture of natural wood materials, laminates, and other covering materials.
- › Damages or failures resulting from misuse, abuse, negligence, improper care, modifications, or relocation.
- › Non Commercial use or locations.
- › So-called "ghost" indentions and similar damage caused by the failure to use appropriate desk or writing pads.

All Warranty Claims are subject to DARRAN-approved inspections. Disputes may involve independent third-party evaluation

QUALITY ASSURANCE

DARRAN manufactures in accordance with the standards set by Architectural Woodwork Institute (AWI) for Quality Standards.

Every unit produced at DARRAN is completely inspected by an independent quality control team located within each plant whose emphasis is on assembly, finish, and final inspections with empowerment to stop any unit not meeting DARRAN's high quality standards.

GLASS

Use of glass overlays on surfaces will void DARRAN's Limited Lifetime Warranty, unless the overlay is installed and

maintained in strict accordance with DARRAN's instructions. If an overlay is to be used, please contact DARRAN for installation and maintenance instructions.

GENERAL

Performance questions will be tested to generally accepted practices and AWI guidelines and standards for wood veneer furniture. To obtain performance of the Limited Lifetime Warranty, the purchaser should contact in writing the authorized DARRAN representatives or current dealer who sold the product to the purchaser or mail the warranty claim to:

Warranty Department
 DARRAN Furniture Industries, Inc.
 P.O. Box 7614
 High Point, NC 27264
 Telephone: 336-861-2400 Toll Free: 800-334-7891
 email: warranty@darran.com

EXCEPT FOR THE LIMITED LIFETIME WARRANTY EXPRESSLY DESCRIBED HEREIN, DARRAN MAKES NO OTHER REPRESENTATION OR WARRANTY OF ANY KIND, EXPRESS OR IMPLIED. DARRAN MAKES NO WARRANTY OF MERCHANTABILITY OR FITNESS FOR A PARTICULAR PURPOSE, AND DARRAN WILL NOT UNDER ANY CIRCUMSTANCES BE LIABLE FOR ANY INCIDENTAL OR CONSEQUENTIAL DAMAGES, OR ANY INDIRECT OR SPECIAL DAMAGES.

THE WARRANTY AS STATED ABOVE, SUPERSEDES ALL PREVIOUS WARRANTIES

NO HASSLE FREIGHT DAMAGED MERCHANDISE

DARRAN products are packed in specially designed cartons and padding that protects all edges and corners from damage. This is proven by an industry low damage rate of .0030% per total pieces shipped.

For qualified freight damage claims DARRAN will take responsibility for the claim and remedy processes including assuming total cost coverage from claim settlements.

(Some items may not qualify. Contact Factory for specific details.)

QUALIFIED CLAIM CONDITIONS**VISIBLE CARTON DAMAGE**

1. Take digital pictures of the damaged carton and damaged furniture if visible damage is found upon delivery at the dock
2. Open all cartons with puncture or crushed corner damage.
3. Note any damage to the goods on the Carrier's freight bill as number of pieces damaged.

CONCEALED DAMAGE

1. Take digital pictures of the furniture as it sits partially unpacked. Also, photograph external and internal carton materials that correspond with the damaged area on the product.
2. Carton and damaged unit(s) must be located at the location matching the original delivery address for Carrier inspection.
3. Digital pictures must be provided of the damaged furniture and carton materials

For qualified claims per above contact DARRAN Customer Service Department at 1-800-334-7891 or complete DARRAN's online warranty report form within the 15 day limit.
www.darran.com/warrantyreport

NON-QUALIFIED CLAIM CONDITIONS

1. Deliveries made to non-dock locations
2. Claims made after furniture is installed and/or removed from original delivery location
3. Carton and padding has been discarded
4. Carrier used was not DARRAN approved
5. Inspection reveals questionable damages

REPLACEMENT ORDERS

Replacement orders entered without replacement tagging or factory authorization is considered a new order without dispute, therefore full payment is expected and will be collected.

RETURN SHIPMENTS

DARRAN will not accept return of merchandise without a signed RA (return authorization) form.

DARRAN will specify the carrier to be used. Return bills of lading must be marked "Class 125" freight rate and a copy of the RA should be used as a packing list. All returns must be received by DARRAN within 30 days of the RA date or the products will be considered accepted by the customer.

All products being returned must be properly packed and protected to avoid freight damage. Whenever possible, use the original cartons in which the merchandise was shipped. Freight

damage, signs of usage, missing parts, etc., will result in an adjustment of any credit to be issued.

DARRAN will issue RA's for the following reasons:

1. Manufacturing defect (inspection required)
2. Order processing error by DARRAN
3. Shipping error
4. Mismatched carton / merchandise

SPECIFICATION CHANGES

We reserve the right to change without notice any dimension, style, or specification of any model in the DARRAN line. Dimensions shown in the price list are nominal. It is the buyer's responsibility to read specification carefully when matching existing goods is desired.

MANUFACTURING DEFECTS

Claims of manufacturing defects will not be entertained without prior consultation with DARRAN's warranty department. Unauthorized deduction in payment of invoices will not be allowed without prior factory approval. Unapproved deductions are subject to factor's late payment charges.

DAMAGE CLAIMS

Claims of manufacturing damage or freight damage reported as nicks, dents, scratches, etc. after installation of furniture will not be covered under warranty or freight claim.

ATTENTION: Damage claims involving glass or stone components must be inspected and damage noted on delivering freight bill to qualify for replacement.

REPAIR CHARGES

Factory authorization must be secured from DARRAN's warranty department prior to incurring repair charges. Warranty will utilize DARRAN's National Repair Service through the Furniture Medic Franchise (www.furnituremedic.com).

Repair charge authorizations are based on:

- › Set travel rate
- › Average regional job rate
- › Factory set maximum repair time
- › Falsely reported defect claims are subject to local service charges being charged to dealer/distributor.

ORDERING

All orders should be emailed, mailed or transmitted by fax to:

DARRAN Furniture Industries, Inc.
P.O. Box 7614
High Point, NC 27264
email: orders@darran.com
Fax: 336-861-6485

DARRAN will only accept orders from authorized Dealers. All orders must be accurate and detailed. All Quick Ship orders must contain Quick Ship product ONLY. Orders should be separated and submitted according to lead time. Orders must contain Quick Ship code "QS" or have designated Quick Ship lead time to ensure correct order entry. Orders that contain multiple lead time products will be entered as one order and scheduled with the most extended lead time.

CREDIT APPROVAL

All orders are subject to credit approval for open account. All new accounts must be approved by a local DARRAN Sales Representative and should submit current financial information and trade references to:

DARRAN Furniture Industries, Inc. ATTN: Credit Department
P.O. Box 7614
High Point, NC 27264
Telephone: 336-861-2400 Toll Free: 800-334-7891
Fax: 336-861-2512

Orders submitted without accounts pre-approval or credit approval are subject to acceptance with lead times scheduled only after approval dates.

LEAD TIME SCHEDULE

DARRAN cannot assign a firm lead time until Credit approval and order accuracy are complete. Extended lead times due to credit or information delays are the responsibility of the Buyer.

ORDER DELAY / HOLD

Due to the committed manufacturing cost on Quick Ship processes, DARRAN cannot delay or hold orders, either in process or after completion.

CANCELLATION AND ORDER CHANGES - FEES

Acknowledged orders are considered firm orders and therefore not subject to cancellation or change. However, in the event we are able to stop an order prior to manufacturing process, we will consider cancellation or changes with a reprocessing fee of \$40.00 Net. Exceptions: Quickship orders cannot be changed or canceled after the 3rd business date after acknowledgment. Qualified changes/cancellations will be assessed a \$40.00 Net processing fee.

Changes or cancellation of order with special options or custom quoted items are also subject to additional material and vendor fee costs, plus a DARRAN special/custom reprocessing fee of \$100 NET.

ORDER MOVEUPS

Should an original scheduled ship date need to be improved, the Factory must be contacted 15 business days prior to the desired ship date. Move ups are subject to schedule availability.

ORDER ACKNOWLEDGMENT

Upon credit approval your order will be acknowledged and identified by an order number. When making reference to your order, please use this order number. Your acknowledgment is a detailed description of our interpretation of your order, pricing, shipping information, and estimated delivery date.

If you have not received an Acknowledgment within 10 Days of order issue, contact Customer Service immediately. All Quick Ship order acknowledgments will be faxed or emailed upon request to speed processing. Please read your acknowledgment carefully for correctness and notify DARRAN immediately of any discrepancies. Failure to notify relieves DARRAN from error liability.

Order acknowledgment is the final agreement between DARRAN and the customer superseding all previous communications regarding the order. DARRAN will not be responsible for errors made on orders placed by phone without written confirmation.

SELLING INFORMATION

Possession of this price list does not in itself constitute the right to sell DARRAN products. DARRAN products are sold and distributed through authorized dealerships. Contact factory for a listing of local representatives and dealerships.

INVOICE TERMS

Standard terms are NET 30 days. Finance charges of 1-1/2% will be added to delinquent accounts after 45 Days and for each 30 Days thereafter until paid.

Complaints involving newly received merchandise must be reported within 10 days from receipt to qualify for full invoice remittance suspension or term extension. Otherwise only items in dispute can be suspended from payment of invoice within terms.

WAREHOUSE/STORAGE

DARRAN will determine order warehousing approvals on a case by case basis. Orders that can be accommodated will be limited to a max of 30 days storage and must be invoiced at time of storage. Orders that exceed factory storage capacity will be transferred to local storage facilities subject to current storage rates and handling-transit charges. Storage charges must be paid prior to order release to shipping.

**EXECUTIVE OFFICE & CONFERENCE ROOM
FURNITURE**

November 3, 2015 through November 2, 2020

FSC Group 71

GSA CONTRACT NUMBER: GS-27F-001DA

Business Classification:

WBENC Certified Woman-Owned Small Business

DARRAN FURNITURE INDUSTRIES

2402 SHORE DRIVE

HIGH POINT, NC 27263

336.861.2400 FAX 336.861.6485

Business Classification:

Woman-Owned Small Business

On-line access to contract ordering information, terms and conditions, up-to-date pricing, and the option to create an electronic delivery order are available through GSA Advantage!, a menu driven database system. The INTERNET address for GSA Advantage is <http://www.fss.gsa.gov>

For more information on ordering from Federal Supply Schedules click on the FSS Schedules button at <http://www.fss.gsa.gov>

1a. Special Item Number

711-8: Executive Office Furniture

711-9: Executive Conference Room Furniture

711-11: Tables and Accessories

711-16: Upholstered Seating

711-18: Multi-purpose Seating

2. Maximum Order Limitations:

711-8 \$500,000

711-9 \$500,000

711-11 \$500,000

711-16 \$300,000

711-18 \$200,000

3. Minimum Order: \$100

4. Geographic Coverage: 48 Contiguous States and the District of Columbia

5. Point of Production: High Point, North Carolina (Randolph County)

6. Discount: Prices shown herein are List (Discount is 56.9% Off List)

7. Quantity Discounts:

• \$467,837 List to \$1,000,000 List = 59.70%

• \$1,000,001 List to \$1,315,789 List = 61.70%

8. Payment Terms: ½% - Net 15 Days, Net 30 Days

8a. Terms and Conditions of Government Credit Card Acceptance:

a. No discount allowed for payment by Government Purchase Card

b. Provide commercial credit card number

c. Provide commercial credit card expiration date

d. Provide individual's name as it appears on

credit card

e. Provide telephone number of individual to whom credit is issued

9a. Government Purchase Cards are accepted below the Micro Purchase Threshold.

9b. Government Purchase Cards are accepted above the Micro Purchase Threshold.

10. Foreign Terms: None

11a. Time of Delivery: Regular Product: 60 - 90 days after receipt of order

Quick Ship Program: Contact DARRAN

11b. Quick Ship Program: Items available for expedited delivery are included in main Price Lists.

11c. Overnight and 2-day delivery: N/A

11d. Urgent Requirements: Will be considered on an individual basis. Contact DARRAN for details.

12. FOB Point: All destinations are limited to Commercial docks only. Carriers may refuse non-dock deliveries.

12a. Freight Prices:

a. All prices shown are suggested list prices with freight included where indicated.

b. Freight allows delivery to one qualified destination.

c. Within the Continental USA, all orders above \$1,500 net are shipped FOB factory, freight prepaid and allowed. All orders less than \$1,500 net will be subject to a \$100 net freight charge.

13. Ordering Address:

DARRAN Furniture Industries

P.O. Box 7614

High Point, NC 27264

Ph: 800.334.7891

Fax: 336.861.6485

13a. Payment Address:

BB&T

P.O. Box 890011

Charlotte, NC 28289-0011

14. Warranty Provision: Limited Lifetime (Contact DARRAN for details)

15. Export Packing Charges: Quoted on request

13. Terms and Conditions: Order Cancellation / Changes.

Restocking/Returns: No merchandise may be returned without a return authorization and shipping instructions. No credit or allowance will be given for repairs to defective materials unless DARRAN has given authority to make such repairs. A restocking charge of 25% will apply.

Cancellation: No cost prior to production. After

GSA CUSTOMER INFORMATION

production has begun, only actual cost incurred will be billed to the Government that cannot be recovered through resale in 6 months

14. Terms and Condition of Rental, Maintenance and Repair: Consult the Factory.

15. Terms and Conditions of Installation: Installation by a Third party to be quoted on a per job basis. The ordering must specify what ranges of installation services are required.

16. Terms and Conditions of Repair Parts: Contact DARRAN for details.

17. List of Service and distribution points: Contact DARRAN for details..

18. Preventative Maintenance: Information enclosed with product.

19. List of Participating Dealers: Contact DARRAN for details.

23. Environmental Attributes: DARRAN is compliant with EPA standards. All plywood core material is CARB 2 compliant and contains recycled content. All DARRAN Casegood Products are BIFMA Level 2 Certified. DARRAN is FSC CoC Certified and our products are MAS Certified for Indoor Air Quality.

23a. Recyclable and Recycled Content Packaging: The corrugated packaging that is supplied to DARRAN, meets the federal mandate that requires the paperboard to be composed of 30%-50% recycled paper, and in some cases the recycled content is close to 100%.

23b. Chemical Emission: DARRAN finishes its products in an ENVI-CT Finish. (Environmental Coatings Technology). DARRAN's seating is finished with a low VOC Conversion Varnish and the casegoods are finished with a formaldehyde free, low VOC Urethane finish. These ENVI-CT finishes allow DARRAN's products to be MAS Certified Green under the ANSI BIFMA X7.1 Standard. Products assist with LEED 4.5 Credit.

23c. Vapor Emissions: DARRAN's ENVI-CT finishes use the latest environmental coatings technology to provide lasting durability and exceptional clarity with BACGUARD Silver anti-microbial protection built-in. The ENVI-CT finishes allows DARRAN casegoods to be MAS Certified Green meeting LEED Credit 4.5.

24a. Duns Number: 08-363-5318

24b. Cage Code: 0Y-6B6

24c. Federal ID Number: 56-117-1971

24d. NAICS Code: 337211

25. SAM Network: DARRAN is registered

SHIPPING SCHEDULE

When requested, DARRAN will assist in locating special express carriers that may have short transit times. These services may exceed our prepaid freight costs; therefore, pricing is limited to the Freight Excluded formula with special express charges added to the invoice.

For special deliveries, DARRAN will make every effort to meet the appointed time; however DARRAN will not be responsible for any additional charges for late deliveries beyond our control.

PRICES

- › All prices shown are suggested list prices with freight included where indicated.
- › Freight allows delivery to one qualified destination.
- › Within the Continental USA, all orders above \$1,500 net are shipped FOB factory, freight prepaid and allowed. All orders less than \$1,500 net will be subject to a \$100 net freight charge.

CALL BEFORE DELIVERY REQUEST

DARRAN will arrange for carriers to call before delivery when requested.

Important Non-Qualified Destinations DARRAN Prepaid Freight Pricing does not include delivery to:

- › Residential Areas
- › Restricted Commercial Areas
- › No Dock Locations
- › Inside delivery/setup service

Orders received and installed without professional Furniture Installers voids all Warranty Coverage.

CARRIER SELECTION

DARRAN selects and uses only carriers specialized in furniture transportation. Customer requested carriers can be authorized using Freight Excluded pricing with invoice add-on.

SPECIFIC DELIVERY TIMES

DARRAN will assist in coordinating a requested delivery time from a carrier. DARRAN makes no guarantees and accepts no responsibility for such services as DARRAN has no control over possible carrier hazards. To ensure specific time arrival, we recommend arranging single stop, designated load carriers. Less than trailer load (LTL) shipments cannot be coordinated for a guaranteed delivery time.

EXPRESS CARRIERS

When requested DARRAN will assist in locating special express carriers that may have short transit times. These services exceed our prepaid freight cost, therefore, pricing is limited to the Freight Excluded formula with special express charges added to invoice.

FEATURES & ADVANTAGES

TFL TOPS

Thermally Fused Laminate tops feature M2 Grade, CARB2 MDF Core with 3-ply balanced construction. Tops are 1-1/8" thick and feature a 2mm flat PVC edge band providing high impact durability. Tops are connected to chassis with steel angle brackets and dowels.

CHASSIS & PEDESTAL CONSTRUCTION

All pedestals and chassis are constructed with 3/4" thick balanced 3-ply panels. Panels are securely fastened together using rails that are bored and doweled, glued, metal reinforcement brackets construction. Thick end panels are pre-bored to accept a tee nut for the adjustable glide and are reinforced with pvc banding to prevent glide tear out. Glue blocks are used where 3/4" thick panels are joined, bored for tee nut to accept adjustable glide.

OVERHEAD CABINET CONSTRUCTION

(FREESTANDING AND WALL MOUNT)

Freestanding Overhead storage cabinets are constructed of 1" and 3/4" thick balanced 3-ply panels. Panels are attached with cam fasteners in conjunction with dowels securely adhered with PVAc (white polyvinyl acetate) glue. All surface mount cabinets connect to work surface with anti-slip tape. Wall mount cabinets are mounted to the wall with steel cabinet hangers with vertical adjustment to attach to the back of the cabinet. All units ship with a steel "z" bracket. This bracket is mounted to the wall by field installers. Installers are responsible for selecting and supplying appropriate fasteners for wall conditions.

BOOKCASE CONSTRUCTION

All chassis (sides, back, top and bottom panels) are constructed with 3/4" thick balanced 3-ply panels. Panels are attached with cam fasteners in conjunction with dowels securely adhered with PVAc (white polyvinyl acetate) glue. Shelves on all units are 3/4" thick balance 3 ply panels.

TACKBOARDS

Wall mount tackboards are constructed of .75" thick fiberboard. The fabric is precisely aligned and fitted to the tackboard with a sock on cover.

Overhead storage tackboards are constructed of .5" thick fiberboard. The fabric is precisely aligned and fitted to the tackboard and adhered to the rigid hardboard with staples.

ADJUSTABLE GLIDES

Glides provide 1" of vertical leveling adjustment. Glide bottom is durable metal.

DRAWERS

All drawers are constructed of four sides and a bottom, which are attached to a drawer front with screws for easy removal. Drawer fronts feature vertically matched veneer within each pedestal. Pencil trays are standard in all box drawers. Capitol Park, Central Park, NSsq, Reception Park, and Richmond Park feature drawers that are 1/2" thick wood grained wrapped

5 sided miter-folded construction with 1/8" thick hardboard bottoms.

SUSPENSIONS

All casegoods utilize cold rolled steel zinc plated high-grade drawer suspensions. All suspensions are warranted for the lifetime of the product. Box and File drawers are full extension, featuring steel ball bearings for a smoother quieter range of motion with soft close operation and are rated 100lbs. Lateral file drawers are a progressive action full extension suspension with the soft close operation and is rated at 150lbs. Lateral files include anti tip mechanism that will allow only one drawer at a time to be opened.

HINGES

Units with doors include 95 degree swing hinges.

FILING

Capitol Park, Central Park, NSsq, Reception Park, and Richmond Park feature a highly durable black plastic extrusion that is securely fastened into a route on top of the drawer.

Desk drawers are provided with a cross bar that allows for adjustability for letter or legal filing side to side, letter width filing front to back without the use of a cross bar. Credenza and Return filing is letter width front to back and legal width side to side without the use of a cross bar, letter width side to side with the use of a cross bar. Lateral files feature legal with filing side to side and two rows of letter width front to back with the use of cross bars. See filing reference section for additional information.

LOCKS

Silver, black or bronze face locks are standard on all desks, credenzas, returns, and modular pedestals and match the color of the pull selection. Locks are optional on door storage, overhead storage, towers with doors and all door units. Each drawer pedestal is independently locked. Lock plugs are factory or field installed.

KEYING

Keying is available either factory or field installed. Factory installed keying offers two options: random or designated. When the random keying option is selected an arbitrary key number will be assigned to the unit. When the designated keying option is selected a key number must be specified if noted on the purchase order and may be factory or field installed. Black and silver face lock have silver keys and bronze face locks have brass keys.

WIRE MANAGEMENT

Wire management capabilities include standard and optional worksurface grommets. When grommets are standard or specified in a unit, wire channels under the surface are provided for organization and management of all communication wires and cords.

GROMMETS

Metal grommets are provided to match the drawer pull selection. Grommet is available in black, silver or white.

Must specify standard or non-standard location. Black plastic grommets are available as an option for vertical applications.

POWERPORTS

A large selection of powerports are available and handle power, data, docking stations and communication. See options section for selection.

LED TASKLIGHTS

LED task lighting provides high efficiency, low energy lighting with long life. LED lights are encased in a silver aluminum alloy material with built in switch to turn the light on/off. Lights are factory installed.

Product specifications listed below:

- Diffuser creates a softer light and eliminates hot spots.
- Built in switch with dimmer control.
- 30w 12Vdc 120V (UL approved) power supply
- Can be "daisy chained" up to 30W
- 50,000 hour life

SIZE	VOLTAGE	WATTAGE	COLOR TEMP.	CRI
24" light	12Vdc	6.4	5000K	90
48" light	12Vdc	12.8	5000K	90
60" light	12Vdc	16	5000K	90

FINISHES

"W" VENEER
Veneer

N/A.....

"G" LAMINATE HPL TOPS
HPL

N/A.....

"M" THERMALLY FUSED LAMINATE
TFL

- MHC Honey Cherry
- MOC KoKo Cherry
- MGW Gunstock Walnut
- MTW Studio Teak Walnut
- MWL Designer White

Send 3x3 or larger finish chip for color match. Custom finish upcharge is 3% or \$250 Net (whichever is greater).

TFL TOPS

Thermally Fused Laminate tops feature M2 Grade, CARB2 MDF Core with 3-ply balanced construction. Tops are 1-1/8" thick and feature a 2mm flat PVC edge band providing high impact durability. Tops are connected to chassis with steel angle brackets and dowels.

DRAWER FRONTS

Drawer fronts are vertically matched in balanced sets. Doors feature vertical veneer bookmatched horizontally in sets of 2 / 4 and 6 doors. All tower fronts matched in vertical sets.

DRAWERS

Drawers feature mitre joint / dowel construction with a natural maple finish. All drawers extend 100% for full access on steel ball bearing slides with cushion in-out stops. Drawers have been tested and passed BIFMA 50,000 cycle test. File drawers feature ¼" bottoms reinforced for heavy weight capacity. All drawers are guaranteed lifetime with free replacement warranty.

OPTIONAL WOOD DRAWERS

Optional hardwood veneer plywood drawers feature banded top and bottom edges for smoothness. Drawers are dowel joint construction with a UV cured finish over maple veneers, plus a lifetime free replacement guarantee.
Optional Wood Drawer (Any Size) – Option Code P33...\$40 List Price Per Drawer

RANDOM LOCKS & KEYING (STANDARD)

Locks are standard on all storage units below the worksurface. Random lock cores are installed at the factory. Some units may be shipped with the same key number. Locks are Silver, Black or Bronze and match pull finish unless specified.

- SRK: Random Silver Random Key - n/c
- BRK: Random Black Random Key - n/c
- ZRK: Random Bronze Random Key - n/c

FIELD INSTALLED LOCKS & KEYING (OPTION)

Field installed lock option can be selected, each unit is shipped with an empty lock cylinder. A separate line item must be ordered to receive the numbered lock cores for field installation. Field installed locks are available at no additional charge. Specify Silver or Black Locks.

- SFK: Field Installed Silver Random Key - n/c
- BFK: Field Installed Black Random Key - n/c
- ZFK: Field Installed Bronze Random Key - n/c

STANDARD PROFILE

Flat Edge

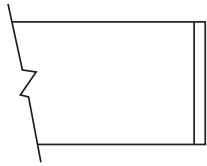

FLAT

3mm solid
hardwood band

PULLS

Factory Installed

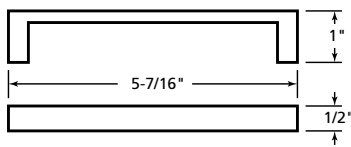

PL-115 Matte Black
PL-116 Matte Nickel

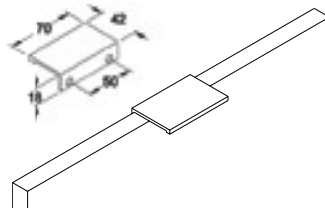

PL-260 Anodized Aluminum
PL-261 White
(Drawers Only)
Optional \$15 list per pull

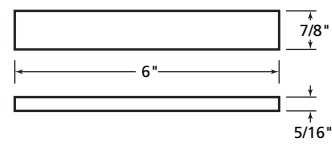

PL-210 Anodized Aluminum

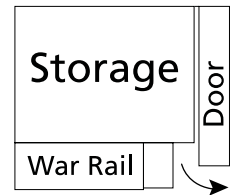

Finger Pull

OPTIONAL GROMMETS

Factory Installed

Grommets (Standard Location)

Specify Color and Left/Right/Center - \$45 ea.

- Black: TM30-R (Right), TM30-L (Left), TM30-C (Center)
- Silver: TM31-R (Right), TM31-L (Left), TM31-C (Center)
- Antique Brass: TM33-R (Right), TM33-L (Left), TM33-C (Center)

Grommets (Non-Standard Location)

Provide drawing w/ Grommet Location and Specify Color - \$90 ea.

- Black: TM30-NS
- Silver: TM31-NS
- Antique Brass: TM33-NS

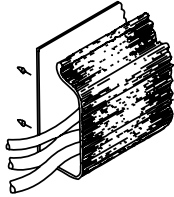

Horizontal J-Channel site management (Sku: W-1) is sold separately to conceal wire under worksurfaces.

W1



GROMMETS (VERTICAL SURFACE)

Standard Location - \$45 ea.

- Black Plastic Vertical Surface: TM50-C (Bottom Center)

Non-Standard Location - \$90 ea.

- Black Plastic Vertical Surface: TM50-NS

STANDARD GROMMET LOCATION REFERENCE

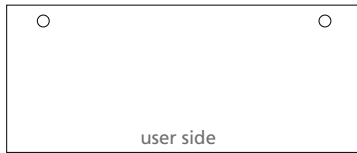

Worksurface

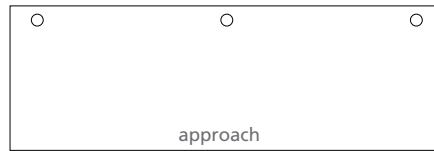

Shared Door Storage

Specify Right, Left or Center Grommet

OVERHEAD DOOR DETAIL

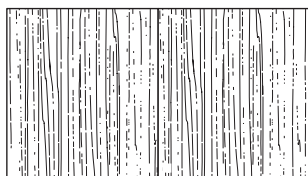

Panel Door

GRAIN DIRECTION



Worksurface

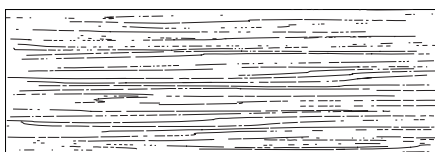

Shared Storage / End Cabinets



Connecting Surface

INTERIOR DRAWER DIMENSIONS

UNIT DEPTH	DRAWER TYPE	OVERALL DIMENSIONS			INTERIOR DRAWER DIMENSIONS			NOTES
		W	D	H	W	D	H	
15-5/8" Letter	36" Box	13-1/8	19-11/16	4	12-1/8	18-11/16	3-7/16	Units less than 72"
	36" File	13-1/8	19-11/16	9-13/16	12-1/8	18-11/16	9-5/16	Units less than 72"
	30" Box	13-1/8	19-11/16	4	12-1/8	18-11/16	3-7/16	Units less than 72"
	30" File	13-1/8	19-11/16	9-13/16	12-1/8	18-11/16	9-5/16	Units less than 72"
	24" Box	13-1/8	16-1/16	4	12-1/8	15-1/16	3-7/16	Units less than 72"
	24" File	13-1/8	16-1/16	9-13/16	12-1/8	15-1/16	9-5/16	Units less than 72"
29" Lateral	24" Box	26-1/2	16-1/16	4	25-1/2	15-1/16	3-7/16	Workstation Credenzas less than 82"
	24" File	26-1/2	16-1/16	9-13/16	25-1/2	15-1/16	9-5/16	Workstation Credenzas less than 82"
31" Lateral	24" File	28-9/16	16-1/16	9-13/16	27-9/16	15-1/16	9-5/16	Multi-File Lateral File
35" Lateral	24" Box	32-1/2	16-1/16	4	31-1/2	15-1/16	3-7/16	Workstation Credenzas over 83"
	24" File	32-1/2	16-1/16	9-13/16	31-1/2	15-1/16	9-5/16	Workstation Credenzas over 83"

FILING REFERENCE

FILING FOR 24" DEPTH UNITS

13 1/8" Wide File Drawer - 16 1/16" Deep

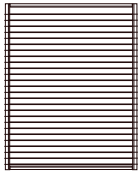

Letter Front to Back

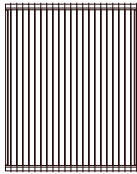

Legal Side to Side with File Rail

FILING FOR 30" & 36" DEPTH UNITS

13 1/8" Wide File Drawer - 19 1/16" Deep

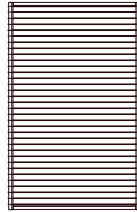

Letter Front to Back

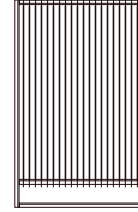

Legal Side to Side with File Rail

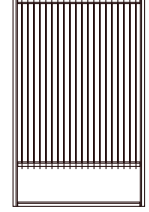

Letter Side to Side with File Rail

29" LATERAL FILE DRAWER

26-1/2" Wide File Drawer - 16-1/16" Deep

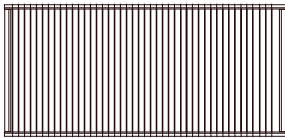

Legal Side to Side

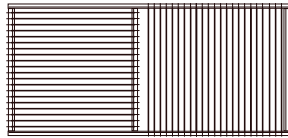

Legal Side to Side Letter Front to Back with File Rail

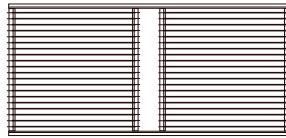

Letter Front to Back with File Rail

35" LATERAL FILE DRAWER

32-1/2" Wide File Drawer - 16-1/16" Deep

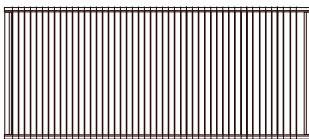

Legal Side to Side

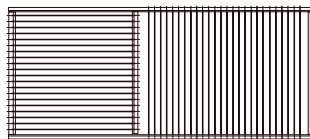

Legal Side to Side Letter Front to Back with File Rail

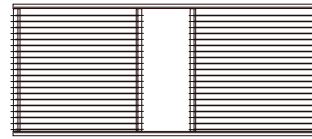

Letter Front to Back with File Rail

STYLE NUMBER LIST PRICE

STARTER UNITS



VIL-DCH HARDWIRED \$600
Includes (1) Villa unit with 120" Hardwire Infeed



VIL-DCP PLUG \$695
Includes (1) Villa with Plug Infeed - Includes 72" Cord and 32" Infeed Jumper for 104" total cord infeed

ADDITIONAL LINKING UNITS

VIL-DCL ADDITIONAL \$590
(Includes linking Villa and Jumper cable up to 96")

SPECIFICATIONS

- Size: Top Grommet 5.68" L X 3.39"W; Under Top 12"L x 3.13"W x 3.08"D
- (4) Power receptacles; (2) surface and (2) undersurface, (2) 2.1A USB charging ports and (1) Knockout for RJ45 Data Port
- Surface Mount
- Daisy Chain - Hardwire Max (10) Units, Plug/Corded Max (5) Units
- Standard Silver Finish, Black Finish available upon request
- UL or ETL Certified

AVAILABLE

- All Darran Collections
- Excludes Grove



RJ45 KNOCKOUT

STYLE NUMBER	LIST PRICE
RJ45 (1)	\$35



W17 - WIRE MANAGEMENT COVER

NOT SO square has special metal covers that attach to legs to handle wires to the floor. The cover may be attached to the inside of any leg with magnets for each removal.

All metal legs and supports have wire management covers available in silver, white or black.

METAL LEG OFFERING

All metal is standard silver.

Cabinet Angular Foot
Cast Metal Leg

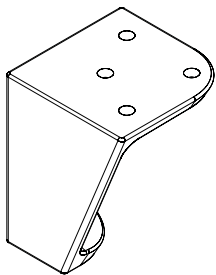
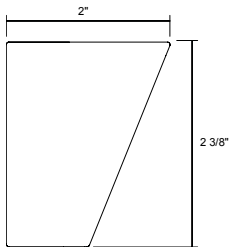

Angular Base
30" and 61"

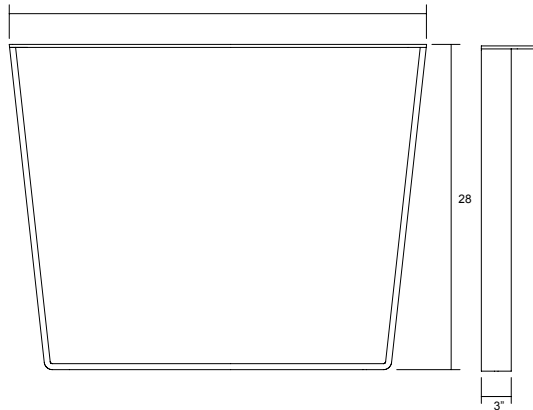

Overhead Support

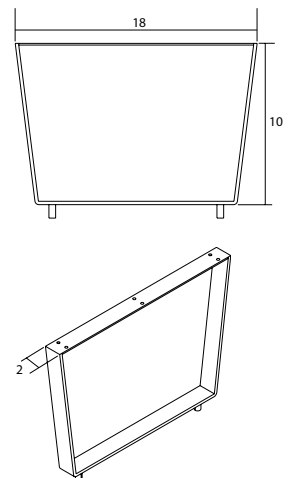

Use pre-assembled electrical packages or specify your own available plug or hardware.

Double sided overheads give each person personal storage.



ELECTRICAL FEATURES - NON-ADJUSTABLE HEIGHT

Power System Kits are built to include all power receptacles and cables needed for a plug or hardwire system based on the number of people and the type of workstation application. All units include Power Systems (a double sided duplex receptacles - 2 up and 2 down - 4 circuit hardwire and 1 circuit plug). Jumper and Flex cables as required.

ELECTRICAL SYSTEM NON-ADJUSTABLE HEIGHT

2 PERSON STATIONS - FACING

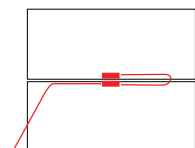

Hardwired

STYLE NUMBER
NA2PFH

DESCRIPTION
**2 PERSON FACING HARDWIRE SYSTEM FOR
NON-ADJUSTABLE HEIGHT STATION**

TOTAL LIST
\$1,115

System Consists of:

VIL-DCH	Villa Hardwired	qty.	1
VIL-DCL	Additional Villa Linking Unit		1
OPTIONAL RJ45	(2) RJ45 Communication Units for Knockout		Add \$70

Includes:

- (2) Villa units each including (4) Power receptacles; (2) surface and (2) undersurface, (2) 2.1A USB charging ports, and (1) knock out for RJ45 data port
- (1) 120" hardwire Starter, Flex Cable
- (1) 48" jumper flex cable
- Top grommet size is 5.68" x 3.39" with flush style lid and brush for use when closed
- Standard silver finish. Black or white finish available upon specification

STYLE NUMBER
NA2PFP

DESCRIPTION
**2 PERSON FACING PLUG SYSTEM
FOR NON-ADJUSTABLE HEIGHT STATION**

TOTAL LIST
\$1,210

System Consists of:

VIL-DCP	Villa Plug	qty.	1
VIL-DCL	Additional Villa Linking Unit		1
OPTIONAL RJ45	(2) RJ45 Communication Units for Knockout		Add \$70

Includes:

- (2) Villa units each including (4) Power receptacles; (2) surface and (2) undersurface, (2) 2.1A USB charging ports, and (1) knock out for RJ45 data port
- (1) 72" flex cable with (1) 32" jumper flex cable for 104" total cord infeed
- (1) 48" jumper flex cable
- Top grommet size is 5.68" x 3.39" with flush style lid and brush for use when closed
- Standard silver finish. Black or white finish available upon specification

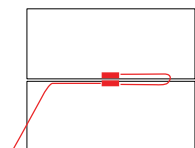

Plug

**ELECTRICAL SYSTEM
NON-ADJUSTABLE HEIGHT**

ELECTRICAL FEATURES - NON-ADJUSTABLE HEIGHT

2 PERSON STATION - INLINE

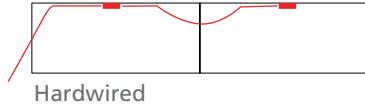

STYLE NUMBER
NA2PIH

DESCRIPTION
**2 PERSON INLINE HARDWIRE SYSTEM
FOR NON-ADJUSTABLE HEIGHT STATION**

TOTAL LIST
\$1,135

System Consists of:

VIL-DCH	Villa Hardwired	1
VIL-DCL	Additional Villa Linking Unit	1
OPTIONAL RJ45	(2) RJ45 Communication Units for Knockout	Add \$70

Includes:

- (2) Villa units each including (4) Power receptacles; (2) surface and (2) undersurface, (2) 2.1A USB charging ports, and (1) knock out for RJ45 data port
- (1) 120" hardwire Starter, Flex Cable
- (1) Jumper Flex Cable, cable length determined by top size
- Top grommet size is 5.68" x 3.39" with flush style lid and brush for use when closed
- Standard silver finish. Black or white finish available upon specification

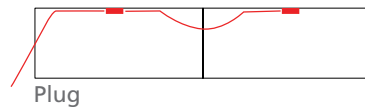

STYLE NUMBER
NA2PIP

DESCRIPTION
**2 PERSON INLINE PLUG SYSTEM
FOR NON-ADJUSTABLE HEIGHT STATION**

TOTAL LIST
\$1,225

System Consists of:

VIL-DCP	Villa Plug	1
VIL-DCL	Additional Villa Linking Unit	1
OPTIONAL RJ45	(2) RJ45 Communication Units for Knockout	Add \$70

Includes:

- (2) Villa units each including (4) Power receptacles; (2) surface and (2) undersurface, (2) 2.1A USB charging ports, and (1) knock out for RJ45 data port
- (1) 72" flex cable with (1) 32" jumper flex cable for 104" total cord infeed
- (1) Jumper Flex Cable, cable length determined by top size
- Top grommet size is 5.68" x 3.39" with flush style lid and brush for use when closed
- Standard silver finish. Black or white finish available upon specification

3 PERSON STATION - INLINE

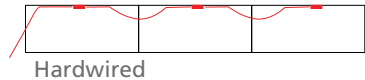

STYLE NUMBER
NA3PIH

DESCRIPTION
**3 PERSON INLINE HARDWIRE SYSTEM
FOR NON-ADJUSTABLE HEIGHT STATION**

TOTAL LIST
\$1,685

System Consists of:

VIL-DCH	Villa Hardwired	1
VIL-DCL	Additional Villa Linking Unit	2
OPTIONAL RJ45	(2) RJ45 Communication Units for Knockout	Add \$105

Includes:

- (3) Villa units each including (4) Power receptacles; (2) surface and (2) undersurface, (2) 2.1A USB charging ports, and (1) knock out for RJ45 data port
- (1) 120" hardwire Starter, Flex Cable
- (2) Jumper Flex Cable, cable length determined by top size
- Top grommet size is 5.68" x 3.39" with flush style lid and brush for use when closed
- Standard silver finish. Black or white finish available upon specification

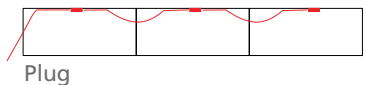

STYLE NUMBER
NA3PIP

DESCRIPTION
**3 PERSON INLINE PLUG SYSTEM
FOR NON-ADJUSTABLE HEIGHT STATION**

TOTAL LIST
\$1,780

System Consists of:

VIL-DCP	Villa Plug	1
VIL-DCL	Additional Villa Linking Unit	2
OPTIONAL RJ45	(2) RJ45 Communication Units for Knockout	Add \$105

Includes:

- (3) Villa units each including (4) Power receptacles; (2) surface and (2) undersurface, (2) 2.1A USB charging ports, and (1) knock out for RJ45 data port
- (1) 72" flex cable with (1) 32" jumper flex cable for 104" total cord infeed
- (2) Jumper Flex Cable, cable length determined by top size
- Top grommet size is 5.68" x 3.39" with flush style lid and brush for use when closed
- Standard silver finish. Black or white finish available upon specification

**ELECTRICAL SYSTEM
NON-ADJUSTABLE HEIGHT**

4 PERSON STATION

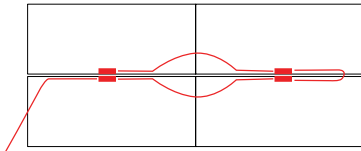

Hardwired

STYLE NUMBER
NA4PFH

System Consists of:
VIL-DCH
VIL-DCL
OPTIONAL RJ45

DESCRIPTION
**4 PERSON FACING HARDWIRE SYSTEM
FOR NON-ADJUSTABLE HEIGHT STATION**

Villa Hardwired
Additional Villa Linking Unit
(4) RJ45 Communication Units for Knockout

TOTAL LIST
\$2,220

qty.
1
3
Add \$140

Includes:

- (4) Villa units each including (4) Power receptacles; (2) surface and (2) undersurface, (2) 2.1A USB charging ports, and (1) knock out for RJ45 data port
- (1) 120" hardwire Starter, Flex Cable
- (2) Jumper Flex Cable, cable length determined by top size, (1) 48" Jumper Flex Cable
- Top grommet size is 5.68" x 3.39" with flush style lid and brush for use when closed
- Standard silver finish. Black or white finish available upon specification

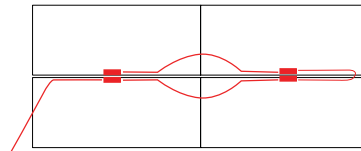

Plug

STYLE NUMBER
NA4PFP

System Consists of:
VIL-DCP
VIL-DCL
OPTIONAL RJ45

DESCRIPTION
**4 PERSON FACING PLUG SYSTEM
FOR NON-ADJUSTABLE HEIGHT STATION**

Villa Plug
Additional Villa Linking Unit
(4) RJ45 Communication Units for Knockout

TOTAL LIST
\$2,450

qty.
1
3
Add \$140

Includes:

- (4) Villa units each including (4) Power receptacles; (2) surface and (2) undersurface, (2) 2.1A USB charging ports, and (1) knock out for RJ45 data port
- (1) 72" flex cable with (1) 32" jumper flex cable for 104" total cord infeed
- (2) Jumper Flex Cable, cable length determined by top size, (1) 48" Jumper Flex Cable
- Top grommet size is 5.68" x 3.39" with flush style lid and brush for use when closed
- Standard silver finish. Black or white finish available upon specification

6 PERSON STATION

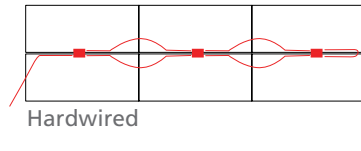

Hardwired

STYLE NUMBER
NA6PFH

System Consists of:
VIL-DCH
VIL-DCL
OPTIONAL RJ45

DESCRIPTION
**6 PERSON FACING HARDWIRE SYSTEM
FOR NON-ADJUSTABLE HEIGHT STATION**

Villa Hardwired
Additional Villa Linking Unit
(6) RJ45 Communication Units for Knockout

TOTAL LIST
\$3,320

qty.
1
5
Add \$210

Includes:

- (6) Villa units each including (4) Power receptacles; (2) surface and (2) undersurface, (2) 2.1A USB charging ports, and (1) knock out for RJ45 data port
- (1) 120" hardwire Starter, Flex Cable
- (4) Jumper Flex Cable, cable length determined by top size, (1) 48" Jumper Flex Cable
- Top grommet size is 5.68" x 3.39" with flush style lid and brush for use when closed
- Standard silver finish. Black or white finish available upon specification

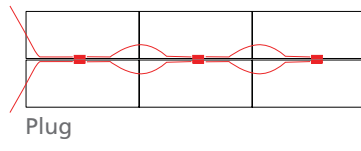

Plug

STYLE NUMBER
NA6PFP

System Consists of:
VIL-DCP
VIL-DCL
OPTIONAL RJ45

DESCRIPTION
**6 PERSON FACING PLUG SYSTEM
FOR NON-ADJUSTABLE HEIGHT STATION**

Villa Plug
Additional Villa Linking Unit
(6) RJ45 Communication Units for Knockout

TOTAL LIST
\$3,555

qty.
1
5
Add \$210

Includes:

- (6) Villa units each including (4) Power receptacles; (2) surface and (2) undersurface, (2) 2.1A USB charging ports, and (1) knock out for RJ45 data port
- (2) 72" flex cable with (2) 32" jumper flex cable for 104" total cord infeed
- (4) Jumper Flex Cable, cable length determined by top size
- Top grommet size is 5.68" x 3.39" with flush style lid and brush for use when closed
- Standard silver finish. Black or white finish available upon specification

Power System Kits for Adjustable Height units are built to include all necessary power receptacles and longer cables needed for adjustable height application. All units include Power Systems (a double sided duplex receptacles - 4 up and 4 down - 4 circuit hardwire and 1 circuit plug). Jumper and Flex cables as required.

If Power System Kits are not desired, a Single Cover power unit (PD-Cove) is also available as a simple power pod inserted into the workstation top.

**ELECTRICAL SYSTEM
ADJUSTABLE HEIGHT**

1 PERSON STATION

 <p>Hardwired</p>	<p>STYLE NUMBER AH1PSH</p>	<p>DESCRIPTION 1 PERSON SINGLE HARDWIRE SYSTEM FOR ADJUSTABLE HEIGHT STATIONS</p>	<p>TOTAL LIST \$600</p>
	<p>System Consists of: VIL-DCH OPTIONAL RJ45</p>	<p>Villa Hardwired (2) RJ45 Communication Units for Knockout</p>	<p>qty. 1 Add \$70</p>

Includes:

- Villa unit includes (4) Power receptacles; (2) surface and (2) undersurface, (2) 2.1A USB charging ports, and (1) knock out for RJ45 data port
- (1) 120" hardwire Starter, Flex Cable
- Top grommet size is 5.68" x 3.39" with flush style lid and brush for use when closed
- Standard silver finish. Black or white finish available upon specification

1 PERSON STATION

 <p>Plug</p>	<p>STYLE NUMBER AH1PSP</p>	<p>DESCRIPTION 1 PERSON SINGLE PLUG SYSTEM FOR ADJUSTABLE HEIGHT STATIONS</p>	<p>TOTAL LIST \$695</p>
	<p>System Consists of: VIL-DCP OPTIONAL RJ45</p>	<p>Villa Plug (2) RJ45 Communication Units for Knockout</p>	<p>qty. 1 Add \$70</p>

Includes:

- Villa unit includes (4) Power receptacles; (2) surface and (2) undersurface, (2) 2.1A USB charging ports, and (1) knock out for RJ45 data port
- (1) 72" flex cable with (1) 32" jumper flex cable for 104" total cord infeed
- Top grommet size is 5.68" x 3.39" with flush style lid and brush for use when closed
- Standard silver finish. Black or white finish available upon specification

**ELECTRICAL SYSTEM
ADJUSTABLE HEIGHT**

ELECTRICAL FEATURES - ADJUSTABLE HEIGHT (CONT.)

2 PERSON STATION - INLINE

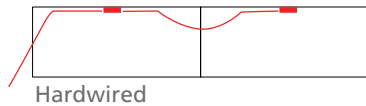

STYLE NUMBER
AH2PIH

DESCRIPTION
**2 PERSON INLINE HARDWIRE SYSTEM
FOR ADJUSTABLE HEIGHT STATIONS**

TOTAL LIST
\$1,205

System Consists of:

VIL-DCH
VIL-DCL
OPTIONAL RJ45

Villa Hardwired
Additional Villa Linking Unit
(2) RJ45 Communication Units for Knockout

qty.
1
1
Add \$70

Includes:

- (2) Villa units each including (4) Power receptacles; (2) surface and (2) undersurface, (2) 2.1A USB charging ports, and (1) knock out for RJ45 data port
- (1) 120" hardwire Starter, Flex Cable
- (1) Jumper Flex Cables, cable length determined by top size
- Top grommet size is 5.68" x 3.39" with flush style lid and brush for use when closed
- Standard silver finish. Black or white finish available upon specification

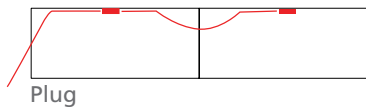

STYLE NUMBER
AH2PIP

DESCRIPTION
**2 PERSON INLINE PLUG SYSTEM
FOR ADJUSTABLE HEIGHT STATIONS**

TOTAL LIST
\$1,300

System Consists of:

VIL-DCP
VIL-DCL
OPTIONAL RJ45

Villa Plug
Additional Villa Linking Unit
(2) RJ45 Communication Units for Knockout

qty.
1
1
Add \$70

Includes:

- (2) Villa units each including (4) Power receptacles; (2) surface and (2) undersurface, (2) 2.1A USB charging ports, and (1) knock out for RJ45 data port
- (1) 72" flex cable with (1) 32" jumper flex cable for 104" total cord infeed
- (1) Jumper Flex Cables, cable length determined by top size
- Top grommet size is 5.68" x 3.39" with flush style lid and brush for use when closed
- Standard silver finish. Black or white finish available upon specification

3 PERSON STATION - INLINE

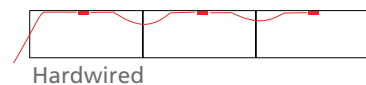

STYLE NUMBER
AH3PIH

DESCRIPTION
**3 PERSON INLINE HARDWIRE SYSTEM
FOR ADJUSTABLE HEIGHT STATIONS**

TOTAL LIST
\$1,830

System Consists of:

VIL-DCH
VIL-DCL
OPTIONAL RJ45

Villa Hardwired
Additional Villa Linking Unit
(3) RJ45 Communication Units for Knockout

qty.
1
2
Add \$105

Includes:

- (3) Villa units each including (4) Power receptacles; (2) surface and (2) undersurface, (2) 2.1A USB charging ports, and (1) knock out for RJ45 data port
- (1) 120" hardwire Starter, Flex Cable
- (2) Jumper Flex Cables, cable length determined by top size
- Top grommet size is 5.68" x 3.39" with flush style lid and brush for use when closed
- Standard silver finish. Black or white finish available upon specification

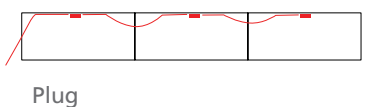

STYLE NUMBER
AH3PIP

DESCRIPTION
**3 PERSON INLINE PLUG SYSTEM
FOR ADJUSTABLE HEIGHT STATIONS**

TOTAL LIST
\$1,920

System Consists of:

VIL-DCP
VIL-DCL
OPTIONAL RJ45

Villa Plug
Additional Villa Linking Unit
(3) RJ45 Communication Units for Knockout

qty.
1
2
Add \$105

Includes:

- (3) Villa units each including (4) Power receptacles; (2) surface and (2) undersurface, (2) 2.1A USB charging ports, and (1) knock out for RJ45 data port
- (1) 72" flex cable with (1) 32" jumper flex cable for 104" total cord infeed
- (2) Jumper Flex Cables, cable length determined by top size
- Top grommet size is 5.68" x 3.39" with flush style lid and brush for use when closed
- Standard silver finish. Black or white finish available upon specification

**ELECTRICAL SYSTEM
ADJUSTABLE HEIGHT**

4 PERSON STATION

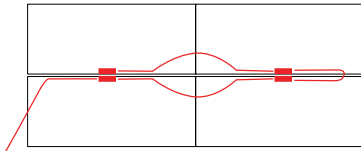

Hardwired

STYLE NUMBER
AH4PFH

System Consists of:
VIL-DCH
VIL-DCL
OPTIONAL RJ45

Includes:

- (4) Villa units each including (4) Power receptacles; (2) surface and (2) undersurface, (2) 2.1A USB charging ports, and (1) knock out for RJ45 data port
- (1) 120" hardwire Starter, Flex Cable
- (3) Jumper Flex Cables, cable length determined by top size
- Top grommet size is 5.68" x 3.39" with flush style lid and brush for use when closed
- Standard silver finish. Black or white finish available upon specification

DESCRIPTION
**4 PERSON FACING HARDWIRE SYSTEM
FOR ADJUSTABLE HEIGHT STATIONS**

Villa Hardwired
Additional Villa Linking Unit
(4) RJ45 Communication Units for Knockout

TOTAL LIST
\$2,370

qty.
1
3
Add \$140

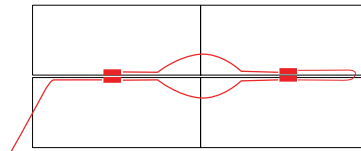

Plug

STYLE NUMBER
AH4PFP

System Consists of:
VIL-DCP
VIL-DCL
OPTIONAL RJ45

Includes:

- (4) Villa units each including (4) Power receptacles; (2) surface and (2) undersurface, (2) 2.1A USB charging ports, and (1) knock out for RJ45 data port
- (1) 72" flex cable with (1) 32" jumper flex cable for 104" total cord infeed
- (3) Jumper Flex Cables, cable length determined by top size
- Top grommet size is 5.68" x 3.39" with flush style lid and brush for use when closed
- Standard silver finish. Black or white finish available upon specification

DESCRIPTION
**4 PERSON FACING PLUG SYSTEM
FOR ADJUSTABLE HEIGHT STATIONS**

Villa Plug
Additional Villa Linking Unit
(4) RJ45 Communication Units for Knockout

TOTAL LIST
\$2,385

qty.
1
3
Add \$140

6 PERSON STATION

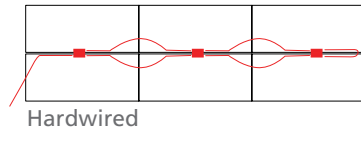

Hardwired

STYLE NUMBER
AH6PFH

System Consists of:
VIL-DCH
VIL-DCL
OPTIONAL RJ45

Includes:

- (6) Villa units each including (4) Power receptacles; (2) surface and (2) undersurface, (2) 2.1A USB charging ports, and (1) knock out for RJ45 data port
- (1) 120" hardwire Starter, Flex Cable
- (5) Jumper Flex Cables, cable length determined by top size
- Top grommet size is 5.68" x 3.39" with flush style lid and brush for use when closed
- Standard silver finish. Black or white finish available upon specification

DESCRIPTION
**6 PERSON FACING HARDWIRE SYSTEM
FOR ADJUSTABLE HEIGHT STATIONS**

Villa Hardwired
Additional Villa Linking Unit
(6) RJ45 Communication Units for Knockout

TOTAL LIST
\$3,550

qty.
1
5
Add \$210

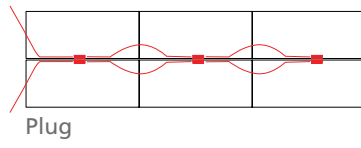

Plug

STYLE NUMBER
AH6PFP

System Consists of:
VIL-DCP
VIL-DCL
OPTIONAL RJ45

Includes:

- (6) Villa units each including (4) Power receptacles; (2) surface and (2) undersurface, (2) 2.1A USB charging ports, and (1) knock out for RJ45 data port
- (2) 72" flex cable with (2) 32" jumper flex cable for 104" total cord infeed
- (4) Jumper Flex Cables, cable length determined by top size
- Top grommet size is 5.68" x 3.39" with flush style lid and brush for use when closed
- Standard silver finish. Black or white finish available upon specification

DESCRIPTION
**6 PERSON FACING PLUG SYSTEM
FOR ADJUSTABLE HEIGHT STATIONS**

Villa Plug
Additional Villa Linking Unit
(6) RJ45 Communication Units for Knockout

TOTAL LIST
\$3,565

qty.
1
5
Add \$210

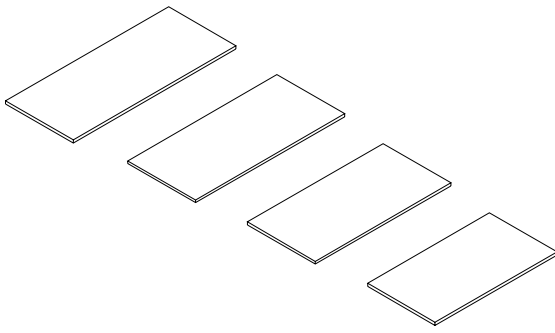

WORKSURFACE TOPS

STANDARD FEATURES

- Joins two adjustable height mechs - 1.125 Inches thick melamine with PVC edge
- Surfaces 66" and over have two horizontal support rods
- Wire trough will be cut into top surface if specified
- Work surface may be connected to end leg, middle leg, case and privacy end panel

- Privacy cannot be used on 54" when using power trough

NOTES

[CLICK HERE TO VIEW PRODUCT INDEX](#)

1 SELECT A STYLE

DIMENSIONS		STYLE NUMBER	LIST PRICE	STYLE NUMBER	LIST PRICE	STYLE NUMBER	LIST PRICE
W" x D" x H"	WGT	"W" Veneer Top Veneer Chassis		"G" High Pressure Laminate Top HPL Veneer Chassis		"M" Thermally Fused Laminate Top Thermally Fused Laminate Chassis	
72 x 30 x 1.125	75	"W" option N/A		"G" option N/A		NSS7230OP700M	494
66 x 30 x 1.125	70	"W" option N/A		"G" option N/A		NSS6630OP700M	483
60 x 30 x 1.125	60	"W" option N/A		"G" option N/A		NSS6030OP700M	420
54 x 30 x 1.125	55	"W" option N/A		"G" option N/A		NSS5430OP700M	410

2 SELECT A FINISH

"W" Veneer	"G" HPL	"M" TFL	Finish
-	-	MHC	Honey Cherry
-	-	MOC	Koko Cherry
-	-	MGW	Gunstock Walnut
-	-	MTW	Studio Teak Walnut
-	-	MWL	Designer White

3 SELECT AN EDGE



Flat 2 mm

4 SELECT HARDWARE

Hardware Option Not Available

5 OPTIONS

GROMMETS (STANDARD LOCATION)

- Specify Color and Location (Right/Left/Center) - \$45 ea.
- Black: TM30-R (Right), TM30-L (Left), TM30-C (Center)
 - Silver: TM31-R (Right), TM31-L (Left), TM31-C (Center)
 - White: TM34-R (Right), TM34-L (Left), TM34-C (Center)

GROMMETS (NON-STANDARD LOCATION)

- Provide drawing w/ grommet location and specify color - \$90 ea.
- Black: TM30-NS
 - Silver: TM32-NS
 - White: TM34-NS

VILLA POWER POD

- Please reference Villa Power System on pg 17-25

EXPOSED PLYWOOD EDGE

- WEPB: Exposed Plywood Edge w/ Baltic Birch Veneer - n/c
- Only available with WCF - Clear Coat Finish

PLANK MATCH VENEER

- 72 x 30 Top: \$ 1,205
- 66 x 30 Top: \$1,175
- 60 x 30 Top: \$1,145
- 54 x 30 Top: \$1,115

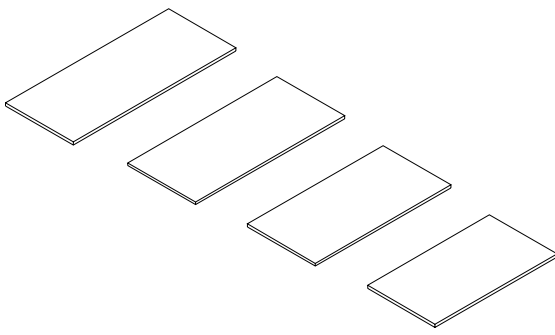

WORKSURFACE TOPS WITH EXPOSED PLYWOOD EDGE

STANDARD FEATURES

- 1.125" Tops w/ exposed plywood edge
- Surfaces 66" and over have two horizontal support rods
- Wire trough will be cut into top surface if specified
- Work surface may be connected to end leg, middle leg, case and privacy end panel

power trough

NOTES

- Privacy cannot be used on 54" when using

[CLICK HERE TO VIEW PRODUCT INDEX](#)

1 SELECT A STYLE

DIMENSIONS		STYLE NUMBER	LIST PRICE	STYLE NUMBER	LIST PRICE	STYLE NUMBER	LIST PRICE
W" x D" x H"	WGT	"W" Veneer Veneer Top Veneer Chassis		"G" HPL High Pressure Laminate Top Veneer Chassis		"M" TFL Thermally Fused Laminate Top Thermally Fused Laminate Chassis	
72 x 30 x 1.5	75	"W" option N/A		NSS7230OP800G	1195	"M" option N/A	
66 x 30 x 1.5	70	"W" option N/A		NSS6630OP800G	1185	"M" option N/A	
60 x 30 x 1.5	60	"W" option N/A		NSS6030OP800G	1175	"G" option N/A	
54 x 30 x 1.5	55	"W" option N/A		NSS5430OP800G	1165	"M" option N/A	

2 SELECT A FINISH

"W" Veneer	"G" HPL	"M" TFL	
-	GHC	-	Honey Cherry
-	GOC	-	Koko Cherry
-	GWC	-	Wheat Cherry
-	GCM	-	Clear Maple
-	GEW	-	Executive Walnut
-	-	MGW	Gunstock Walnut
-	-	MTW	Studio Teak Walnut
-	GWL	-	Designer White

3 SELECT AN EDGE



4 SELECT HARDWARE

Hardware Option Not Available

5 OPTIONS

GROMMETS (STANDARD LOCATION)

- Specify Color and Location (Right/Left/Center) - \$45 ea.
- Black: TM30-R (Right), TM30-L (Left), TM30-C (Center)
 - Silver: TM31-R (Right), TM31-L (Left), TM31-C (Center)
 - White: TM34-R (Right), TM34-L (Left), TM34-C (Center)

GROMMETS (NON-STANDARD LOCATION)

- Provide drawing w/ grommet location and specify color - \$90 ea.
- Black: TM30-NS
 - Silver: TM32-NS
 - White: TM34-NS

VILLA POWER POD

- Please reference Villa Power System on pg 17-25

TOP

- MMB: Markerboard top - \$55

EXPOSED PLYWOOD EDGE

- WEPB: Exposed Plywood Edge w/ Baltic Birch Veneer - n/c
- Only available with WCF - Clear Coat Finish

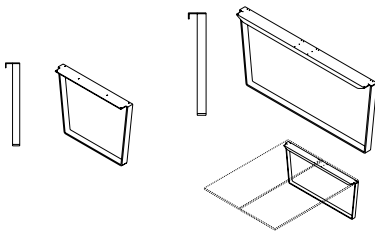

END LEG

STANDARD FEATURES

- One half inch thick steel legs have been laser cut and bent to create unique not so square shape
- Specify end legs with single connection and center legs to connect two tops together
- Standard Silver Leg (optional White, Black)
- Top connection of leg is reinforced with turn downs that will keep tops from warping

[CLICK HERE TO VIEW PRODUCT INDEX](#)

1 SELECT A STYLE

DIMENSIONS		STYLE NUMBER	LIST PRICE	STYLE NUMBER	LIST PRICE	STYLE NUMBER	LIST PRICE
W" x D" x H"	WGT	"L" Leg Metal Leg					
Double leg							
61 x 3 x 27.75	80	ASB61	803				
Single leg							
30 x 3 x 27.75	40	ASB30	588				

2 SELECT A FINISH

"L" Leg	Finish	Price
MFS	Silver	-
MFW	White (Premium Finish)	-
MFB	Black (Premium Finish)	-

3 SELECT AN EDGE

Edge Profile
Option Not Available

5 OPTIONS

- COVER**
- W17: Wire Management cover - \$55 (Attaches to the leg by magnets)
- PREMIUM FINISH OPTION**
- MFB: Black metal finish - \$95 per leg
- MFW: White metal finish - \$95 per leg

4 SELECT HARDWARE

Hardware
Option Not Available

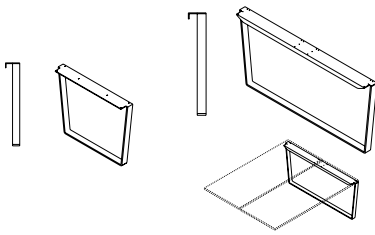

CONNECTING LEG

STANDARD FEATURES

- One half inch thick steel legs have been laser cut and bent to create unique not so square shape
- Specify end legs with single connection and center legs to connect two tops together
- Standard Silver Leg (optional White, Black)
- Top connection of leg is reinforced with turn downs that will keep tops from warping

[CLICK HERE TO VIEW PRODUCT INDEX](#)

1 SELECT A STYLE

DIMENSIONS		STYLE NUMBER	LIST PRICE	STYLE NUMBER	LIST PRICE	STYLE NUMBER	LIST PRICE
W" x D" x H"	WGT	"L" Leg Metal Leg					
Double leg							
61 x 3 x 27.75	90	ASB61DT	814				

2 SELECT A FINISH **3 SELECT AN EDGE** **5 OPTIONS**

"L" Leg			
MFS	-	-	Silver
MFW	-	-	White (Premium Finish)
MFB	-	-	Black (Premium Finish)

Edge Profile
Option Not Available

COVER
- W17: Wire Management cover - \$55 (Attaches to the leg by magnets)

PREMIUM FINISH OPTION
- MFB: Black metal finish - \$95 per leg
- MFW: White metal finish - \$95 per leg

4 SELECT HARDWARE

Hardware
Option Not Available

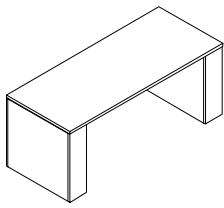

NOT SO SQUARE OPEN

ADJUSTABLE HEIGHT DESK AND UNITS

ADJUSTABLE HEIGHT DESK - WITH ACRYLIC HALF MODESTY PANEL

STANDARD FEATURES

- Acrylic half modesty panel (White)
- Door storage pedestals
- Electronic mechanism with programmable lift
- Max load on frame is 220 lbs
- Metal parts include 5 year warranty
- Motor includes 2 year warranty

- Shipped KD

NOTES

- *Grommets and power pods locations need to be specified on drawings when ordering

[CLICK HERE TO VIEW PRODUCT INDEX](#)

1 SELECT A STYLE

DIMENSIONS	STYLE NUMBER	LIST PRICE	STYLE NUMBER	LIST PRICE	STYLE NUMBER	LIST PRICE
W" x D" x H" 72 x 30 x 29-48	WGT 340	"W" Veneer Top Veneer Chassis "W" option N/A	"G" High Pressure Laminate Top HPL Veneer Chassis "G" option N/A	"M" Thermally Fused Laminate Top TFL Thermally Fused Laminate Chassis NSS7230OP730M	4956	

2 SELECT A FINISH

"W" Veneer	"G" HPL	"M" TFL	Finish
-	-	MHC	Honey Cherry
-	-	MOC	Koko Cherry
-	-	MGW	Gunstock Walnut
-	-	MTW	Studio Teak Walnut
-	-	MWL	Designer White

3 SELECT AN EDGE



Flat 2 mm

5 OPTIONS

ACCESSORIES

- K28: Articulating Keyboard w/ Mouse - \$375

DESK LIGHT

- LT-BEND: Bend Light - specify location - \$145

GROMMETS (STANDARD LOCATION)

Specify Color and Location Right/Left - \$45 ea.

- Black: TM30-R (Right), TM30-L (Left)
- Silver: TM31-R (Right), TM31-L (Left)
- White: TM34-R (Right), TM34-L (Left)

GROMMETS (NON-STANDARD LOCATION)

Provide drawing w/ grommet location and specify color - \$90 ea.

- Black: TM30-NS
- Silver: TM32-NS
- White: TM34-NS

MODESTY

- DM: Delete Modesty Option - Deduct \$350

4 SELECT HARDWARE

Hardware
Option Not
Available

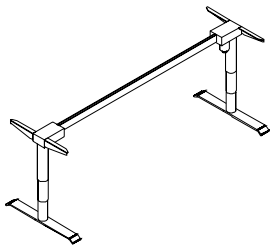

NOT SO SQUARE OPEN ADJUSTABLE HEIGHT DESK AND UNITS

ADJUSTABLE HEIGHT MECHANISM

STANDARD FEATURES

- Electronic mechanism with programmable lift
- Max load on frame is 220 lbs
- Metal parts include 5 year warranty
- Motor includes 2 year warranty

[CLICK HERE TO VIEW PRODUCT INDEX](#)

1 SELECT A STYLE

DIMENSIONS		STYLE NUMBER	LIST PRICE	STYLE NUMBER	LIST PRICE	STYLE NUMBER	LIST PRICE
W" x D" x H"	WGT	"C" Component					
54-72 x 30 x 30-48	160	NSS54300P702	2725				

2 SELECT A FINISH

"C" Comp			
MFS	-	-	Silver
MFW	-	-	White
MFB	-	-	Black

3 SELECT AN EDGE

Edge Profile
Option Not Available

5 OPTIONS

BASE
- MFB: Black metal finish - \$95 per base

4 SELECT HARDWARE

Hardware
Option Not Available

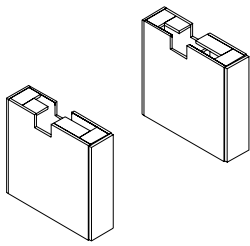

NOT SO SQUARE OPEN ADJUSTABLE HEIGHT DESK AND UNITS

SINGLE LEG PEDESTAL

STANDARD FEATURES

- Single leg, left hinge cabinet, no feet
- Single leg, right hinge cabinet, no feet
- Touch latch

NOTES

- Interior dimensions of storage area: 22" H, 12.75" D, 7.75" W

[CLICK HERE TO VIEW PRODUCT INDEX](#)

1 SELECT A STYLE

DIMENSIONS		STYLE NUMBER	LIST PRICE	STYLE NUMBER	LIST PRICE	STYLE NUMBER	LIST PRICE
W" x D" x H"	WGT	"W" Veneer Top Component Veneer Chassis		"G" High Pressure Laminate Top HPL Veneer Chassis		"M" Thermally Fused Laminate Top TFL Thermally Fused Laminate Chassis	
Left Hinge Storage							
8 x 30 x 28.875	50	"W" option N/A		"G" option N/A		NSS3009OP603M	688
Right Hinge Storage							
8 x 30 x 28.875	50	"W" option N/A		"G" option N/A		NSS3009OP604M	688

2 SELECT A FINISH

"W" Component	"G" HPL	"M" TFL	
-	-	MHC	Honey Cherry
-	-	MOC	Koko Cherry
-	-	MGW	Gunstock Walnut
-	-	MTW	Studio Teak Walnut
-	-	MWL	Designer White

3 SELECT AN EDGE

Edge Profile
Option Not Available

5 OPTIONS

No Options Available

4 SELECT HARDWARE



Touch Latch

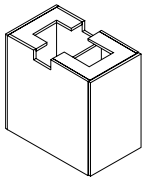

NOT SO SQUARE OPEN ADJUSTABLE HEIGHT DESK AND UNITS

DOUBLE LEG PEDESTAL

STANDARD FEATURES

- Double leg, left hinge cabinet, no Feet
- Joins two adjustable height mechs
- Touch latch

[CLICK HERE TO VIEW PRODUCT INDEX](#)

1 SELECT A STYLE

DIMENSIONS		STYLE NUMBER	LIST PRICE	STYLE NUMBER	LIST PRICE	STYLE NUMBER	LIST PRICE
W" x D" x H"	WGT	"W" Veneer Top Veneer Chassis		"G" HPL High Pressure Laminate Top Veneer Chassis		"M" TFL Thermally Fused Laminate Top Thermally Fused Laminate Chassis	
18 30 x 28.875	85	"W" option N/A		"G" option N/A		NSS3018OP703M	788

2 SELECT A FINISH

"W" Veneer	"G" HPL	"M" TFL	
-	-	MHC	Honey Cherry
-	-	MOC	Koko Cherry
-	-	MGW	Gunstock Walnut
-	-	MTW	Studio Teak Walnut
-	-	MWL	Designer White

3 SELECT AN EDGE

Edge Profile
Option Not Available

5 OPTIONS

No Options Available

4 SELECT HARDWARE



Touch Latch

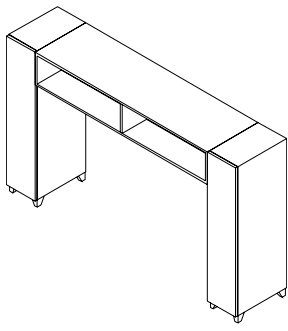

NOT SO SQUARE OPEN STORAGE TOWER KITS - KIT #1

48" H BRIDGE UNIT, OPEN UNIT, OVERHEAD W/ 2 SIDED ACCESS

STANDARD FEATURES

Kit Consists of:

- NSS1018OP709 Wardrobe left hinge (1)
- NSS1018OP710 Wardrobe right hinge (1)
- NSS6118OP711 Overhead open storage - 2 sided access (1)
- Standard Silver Feet and Leg (optional White, Black)
- Touch latch

[CLICK HERE TO VIEW PRODUCT INDEX](#)

1 SELECT A STYLE

DIMENSIONS		STYLE NUMBER	LIST PRICE	STYLE NUMBER	LIST PRICE	STYLE NUMBER	LIST PRICE	
W" x D" x H"	WGT	"W" Veneer Veneer Top Veneer Chassis		"G" HPL High Pressure Laminate Top Veneer Chassis		"M" TFL Thermally Fused Laminate Top Thermally Fused Laminate Chassis		
Wardrobe Left Hinge (1)								
10 x 18 x 48	75	"W" option N/A		"G" option N/A		NSS1018OP709M	772	
Wardrobe Right Hinge (1)								
10 x 18 x 48	75	"W" option N/A		"G" option N/A		NSS1018OP710M	772	
Overhead Open Storage - 2 Sided Access (1)								
61 x 18 x 10	90	"W" option N/A		"G" option N/A		NSS6118OP711M	625	
						Kit #1	NSS8148ST800	2169

2 SELECT A FINISH

"W" Veneer	"G" HPL	"M" TFL	
-	-	MHC	Honey Cherry
-	-	MOC	Koko Cherry
-	-	MGW	Gunstock Walnut
-	-	MTW	Studio Teak Walnut
-	-	MWL	Designer White
Metal Finishes			
MFB	-	-	Black (Premium Finish)
MFS	-	-	Silver
MFW	-	-	White (Premium Finish)

3 SELECT AN EDGE

Edge Profile
Option Not Available

5 OPTIONS

LEGS

- D8: Delete Legs (extended fronts to the floor) - n/c

PREMIUM FINISH OPTION

- MFB: Black metal finish - \$25 per foot
- MFW: White metal finish - \$25 per foot

4 SELECT HARDWARE



Touch Latch

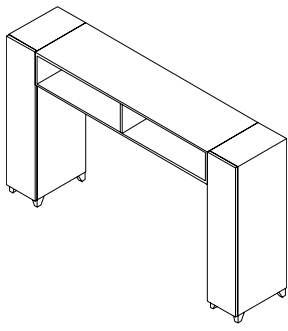

NOT SO SQUARE OPEN

STORAGE TOWER KITS - KIT #2

48" H BRIDGE UNIT, OPEN UNIT, OVERHEAD W/ 1 SIDED ACCESS

STANDARD FEATURES

Kit Consists of:

- NSS1018OP709 Wardrobe left hinge (1)
- NSS1018OP710 Wardrobe right hinge (1)
- NSS6118OP731 Overhead open storage - 1 sided access (1)
- Standard Silver Feet and Leg (optional White, Black)
- Touch latch

[CLICK HERE TO VIEW PRODUCT INDEX](#)

1 SELECT A STYLE

DIMENSIONS		STYLE NUMBER	LIST PRICE	STYLE NUMBER	LIST PRICE	STYLE NUMBER	LIST PRICE	
W" x D" x H"	WGT	"W" Veneer Veneer Top Veneer Chassis		"G" HPL High Pressure Laminate Top Veneer Chassis		"M" TFL Thermally Fused Laminate Top Thermally Fused Laminate Chassis		
Wardrobe Left Hinge (1)								
10 x 18 x 48	75	"W" option N/A		"G" option N/A		NSS1018OP709M	772	
Wardrobe Right Hinge (1)								
10 x 18 x 48	75	"W" option N/A		"G" option N/A		NSS1018OP710M	772	
Overhead Open Storage - 1 Sided Access (1)								
61 x 18 x 10	90	"W" option N/A		"G" option N/A		NSS6118OP731M	625	
						Kit #2	NSS8148ST801	2169

2 SELECT A FINISH

"W" Veneer	"G" HPL	"M" TFL	
-	-	MHC	Honey Cherry
-	-	MOC	Koko Cherry
-	-	MGW	Gunstock Walnut
-	-	MTW	Studio Teak Walnut
-	-	MWL	Designer White
Metal Finishes			
MFB	-	-	Black (Premium Finish)
MFS	-	-	Silver
MFW	-	-	White (Premium Finish)

3 SELECT AN EDGE

Edge Profile
Option Not Available

5 OPTIONS

LEGS

- D8: Delete Legs (extended fronts to the floor) - n/c

PREMIUM FINISH OPTION

- MFB: Black metal finish - \$25 per foot
- MFW: White metal finish - \$25 per foot

4 SELECT HARDWARE



Touch Latch

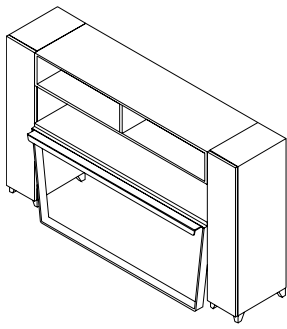

NOT SO SQUARE OPEN

STORAGE TOWER KITS - KIT #3

48" H BRIDGE UNIT, CONNECTING SURFACE, OVERHEAD W/ 2 SIDED ACCESS

STANDARD FEATURES

- Kit Consists of:
- NSS1018OP709 Wardrobe left hinge (1)
- NSS1018OP710 Wardrobe right hinge (1)
- NSS6118OP701 Connecting surface (1)
- NSS6118OP711 Overhead open storage - 2 sided access (1)
- ASB61DT Connecting Leg (2)
- Standard Silver Feet (optional White, Black)
- Touch latch

NOTES

- Clearance from connecting surface to bottom of overhead equals 9.25" height

[CLICK HERE TO VIEW PRODUCT INDEX](#)

1 SELECT A STYLE

DIMENSIONS		STYLE NUMBER	LIST PRICE	STYLE NUMBER	LIST PRICE	STYLE NUMBER	LIST PRICE	
W" x D" x H"	WGT	"W" Veneer Veneer Top Veneer Chassis		"G" HPL High Pressure Laminate Top Veneer Chassis		"M" TFL Thermally Fused Laminate Top Thermally Fused Laminate Chassis		
Wardrobe Left Hinge (1)								
10 x 18 x 48	75	"W" option N/A		"G" option N/A		NSS1018OP709M	772	
Wardrobe Right Hinge (1)								
10 x 18 x 48	75	"W" option N/A		"G" option N/A		NSS1018OP710M	772	
Overhead Open Storage - 2 Sided Access (1)								
61 x 18 x 10	90	"W" option N/A		"G" option N/A		NSS6118OP711M	625	
Connection Surface (1)								
61 x 18 x 1.125	45	"W" option N/A		"G" option N/A		NSS6118OP701M	383	
Connecting Leg								
61 x 3 x .5	90	"W" Option N/A		"G" Option N/A		ASB61DT	814	
						Kit #3	NSS8148ST802	3366

2 SELECT A FINISH

"W" Veneer	"G" HPL	"M" TFL	
-	-	MHC	Honey Cherry
-	-	MOC	Koko Cherry
-	-	MGW	Gunstock Walnut
-	-	MTW	Studio Teak Walnut
-	-	MWL	Designer White
Metal Finishes			
MFB	-	-	Black (Premium Finish)
MFS	-	-	Silver
MFW	-	-	White (Premium Finish)

3 SELECT AN EDGE

Edge Profile
Option Not Available

5 OPTIONS

LEGS

- D8: Delete Legs (extended fronts to the floor) - n/c

PREMIUM FINISH OPTION

- MFB: Black metal finish - \$25 per foot, \$95 per leg
- MFW: White metal finish - \$25 per foot, \$95 per leg

4 SELECT HARDWARE



Touch Latch

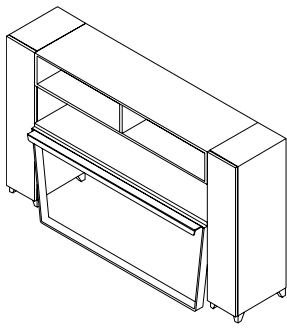

NOT SO SQUARE OPEN

STORAGE TOWER KITS - KIT #4

48" H BRIDGE UNIT, CONNECTING SURFACE, OVERHEAD W/ 1 SIDED ACCESS

STANDARD FEATURES

- NSS1018OP709 Wardrobe left hinge (1)
- NSS1018OP710 Wardrobe right hinge (1)
- NSS6118OP701 Connecting surface (1)
- NSS6118OP731 Overhead open storage - 1 sided access (1)
- ASB61DT Connecting Leg (1)
- Standard Silver Feet (optional White, Black)
- Touch latch

NOTES

- Clearance from connecting surface to bottom of overhead equals 9.25" height

[CLICK HERE TO VIEW PRODUCT INDEX](#)

1 SELECT A STYLE

DIMENSIONS		STYLE NUMBER	LIST PRICE	STYLE NUMBER	LIST PRICE	STYLE NUMBER	LIST PRICE	
W" x D" x H"	WGT	"W" Veneer Veneer Top Veneer Chassis		"G" HPL High Pressure Laminate Top Veneer Chassis		"M" TFL Thermally Fused Laminate Top Thermally Fused Laminate Chassis		
Wardrobe Left Hinge (1)								
10 x 18 x 48	75	"W" option N/A		"G" option N/A		NSS1018OP709M	772	
Wardrobe Right Hinge (1)								
10 x 18 x 48	75	"W" option N/A		"G" option N/A		NSS1018OP710M	772	
Overhead Open Storage - 1 Sided Access (1)								
61 x 18 x 10	90	"W" option N/A		"G" option N/A		NSS6118OP731M	625	
Connection Surface (1)								
61 x 18 x 1.125	45	"W" option N/A		"G" option N/A		NSS6118OP701M	383	
Connecting Leg								
61 x 3 x .5	90	"W" Option N/A		"G" Option N/A		ASB61DT	814	
						Kit #4	NSS8148ST803	3366

2 SELECT A FINISH

"W" Veneer	"G" HPL	"M" TFL	
-	-	MHC	Honey Cherry
-	-	MOC	Koko Cherry
-	-	MGW	Gunstock Walnut
-	-	MTW	Studio Teak Walnut
-	-	MWL	Designer White
Metal Finishes			
MFB	-	-	Black (Premium Finish)
MFS	-	-	Silver
MFW	-	-	White (Premium Finish)

3 SELECT AN EDGE

Edge Profile
Option Not Available

5 OPTIONS

LEGS

- D8: Delete Legs (extended fronts to the floor) - n/c

PREMIUM FINISH OPTION

- MFB: Black metal finish - \$25 per foot, \$95 per leg
- MFW: White metal finish - \$25 per foot, \$95 per leg

4 SELECT HARDWARE



Touch Latch

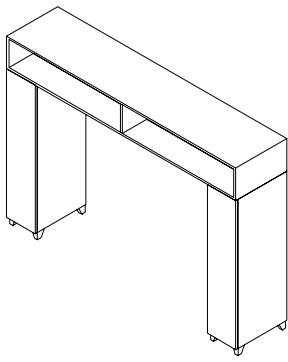

NOT SO SQUARE OPEN

STORAGE TOWER KITS - KIT #5

56" H BRIDGE UNIT, OPEN UNIT, OVERHEAD W/ 2 SIDED ACCESS

STANDARD FEATURES

- Kit Consists of:
- NSS1018OP709 Wardrobe left hinge (1)
 - NSS1018OP710 Wardrobe right hinge (1)
 - NSS8118OP711 Overhead open storage - 2 sided access (1)
 - Standard Silver Feet (optional White, Black)
 - Touch latch

NOTES

- Can be used with height adjustable units

[CLICK HERE TO VIEW PRODUCT INDEX](#)

1 SELECT A STYLE

DIMENSIONS		STYLE NUMBER	LIST PRICE	STYLE NUMBER	LIST PRICE	STYLE NUMBER	LIST PRICE	
W" x D" x H"	WGT	"W" Veneer Veneer Top Veneer Chassis		"G" HPL High Pressure Laminate Top Veneer Chassis		"M" TFL Thermally Fused Laminate Top Thermally Fused Laminate Chassis		
Wardrobe Left Hinge (1)								
10 x 18 x 48	75	"W" option N/A		"G" option N/A		NSS1018OP709M	772	
Wardrobe Right Hinge (1)								
10 x 18 x 48	75	"W" option N/A		"G" option N/A		NSS1018OP710M	772	
Overhead Open Storage - 2 Sided Access (1)								
81 x 18 x 10	100	"W" option N/A		"G" option N/A		NSS8118OP711M	688	
						Kit #5	NSS81565T800	2232

2 SELECT A FINISH

"W" Veneer	"G" HPL	"M" TFL	
-	-	MHC	Honey Cherry
-	-	MOC	Koko Cherry
-	-	MGW	Gunstock Walnut
-	-	MTW	Studio Teak Walnut
-	-	MWL	Designer White
Metal Finishes			
MFB	-	-	Black (Premium Finish)
MFS	-	-	Silver
MFW	-	-	White (Premium Finish)

3 SELECT AN EDGE

Edge Profile
Option Not Available

5 OPTIONS

LEGS

- D8: Delete Legs (extended fronts to the floor) - n/c

PREMIUM FINISH OPTION

- MFB: Black metal finish - \$25 per foot
- MFW: White metal finish - \$25 per foot

4 SELECT HARDWARE



Touch Latch

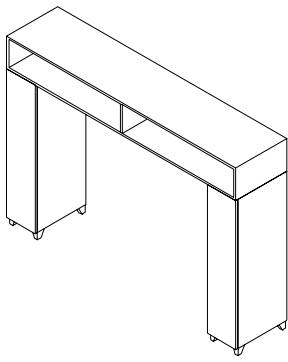

NOT SO SQUARE OPEN
STORAGE TOWER KITS - KIT #6

56" H BRIDGE UNIT, OPEN UNIT, OVERHEAD W/ 1 SIDED ACCESS

STANDARD FEATURES

- Kit Consists of:
- NSS1018OP709 Wardrobe left hinge (1)
 - NSS1018OP710 Wardrobe right hinge (1)
 - NSS8118OP731 Overhead open storage - 1 sided access (1)
 - Standard Silver Feet (optional White, Black)
 - Touch latch

NOTES

- Can be used with height adjustable units

[CLICK HERE TO VIEW PRODUCT INDEX](#)

1 SELECT A STYLE

DIMENSIONS		STYLE NUMBER	LIST PRICE	STYLE NUMBER	LIST PRICE	STYLE NUMBER	LIST PRICE	
W" x D" x H"	WGT	"W" Veneer Veneer Top Veneer Chassis		"G" HPL High Pressure Laminate Top Veneer Chassis		"M" TFL Thermally Fused Laminate Top Thermally Fused Laminate Chassis		
Wardrobe Left Hinge (1)								
10 x 18 x 48	75	"W" option N/A		"G" option N/A		NSS1018OP709M	772	
Wardrobe Right Hinge (1)								
10 x 18 x 48	75	"W" option N/A		"G" option N/A		NSS1018OP710M	772	
Overhead Open Storage - 1 Sided Access (1)								
81 x 18 x 10	100	"W" option N/A		"G" option N/A		NSS8118OP731M	688	
						Kit #6	NSS81565T801	2232

2 SELECT A FINISH

"W" Veneer	"G" HPL	"M" TFL	
-	-	MHC	Honey Cherry
-	-	MOC	Koko Cherry
-	-	MGW	Gunstock Walnut
-	-	MTW	Studio Teak Walnut
-	-	MWL	Designer White
Metal Finishes			
MFB	-	-	Black (Premium Finish)
MFS	-	-	Silver
MFW	-	-	White (Premium Finish)

3 SELECT AN EDGE

Edge Profile
 Option Not Available

5 OPTIONS

- LEGS**
- D8: Delete Legs (extended fronts to the floor) - n/c
- PREMIUM FINISH OPTION**
- MFB: Black metal finish - \$25 per foot
 - MFW: White metal finish - \$25 per foot

4 SELECT HARDWARE



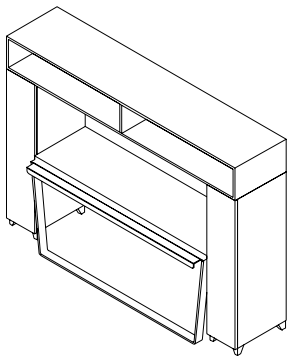

NOT SO SQUARE OPEN

STORAGE TOWER KITS - KIT #7

56" H BRIDGE UNIT, CONNECTING SURFACE, OVERHEAD W/ 2 SIDED ACCESS

STANDARD FEATURES

- NSS1018OP709 Wardrobe left hinge (1)
- NSS1018OP710 Wardrobe right hinge (1)
- NSS8118OP711 Overhead open storage - 2 sided access (1)
- ASB61DT Connecting Leg (2)
- Standard Silver Feet and Leg (optional White, Black)
- Touch latch

NOTES

- Clearance from connecting surface to bottom of overhead equals 19.25" height

[CLICK HERE TO VIEW PRODUCT INDEX](#)

1 SELECT A STYLE

DIMENSIONS		STYLE NUMBER	LIST PRICE	STYLE NUMBER	LIST PRICE	STYLE NUMBER	LIST PRICE	
W" x D" x H"	WGT	"W" Veneer Veneer Top Veneer Chassis		"G" HPL High Pressure Laminate Top Veneer Chassis		"M" TFL Thermally Fused Laminate Top Thermally Fused Laminate Chassis		
Wardrobe Left Hinge (1)								
10 x 18 x 48	75	"W" option N/A		"G" option N/A		NSS1018OP709M	772	
Wardrobe Right Hinge (1)								
10 x 18 x 48	75	"W" option N/A		"G" option N/A		NSS1018OP710M	772	
Overhead Open Storage - 2 Sided Access (1)								
81 x 18 x 10	100	"W" option N/A		"G" option N/A		NSS8118OP711M	688	
Connection Surface (1)								
61 x 18 x 1.125	45	"W" option N/A		"G" option N/A		NSS6118OP701M	383	
Connecting Leg								
61 x 3 x .5	90	"W" Option N/A		"G" Option N/A		ASB61DT	814	
						Kit #7	NSS81565T802	3429

2 SELECT A FINISH

"W" Veneer	"G" HPL	"M" TFL	
-	-	MHC	Honey Cherry
-	-	MOC	Koko Cherry
-	-	MGW	Gunstock Walnut
-	-	MTW	Studio Teak Walnut
-	-	MWL	Designer White
Metal Finishes			
MFB	-	-	Black (Premium Finish)
MFS	-	-	Silver
MFW	-	-	White (Premium Finish)

3 SELECT AN EDGE

Edge Profile
Option Not Available

5 OPTIONS

- LEGS**
- D8: Delete Legs (extended fronts to the floor) - n/c
- PREMIUM FINISH OPTION**
- MFB: Black metal finish - \$25 per foot, \$95 per base
 - MFW: White metal finish - \$25 per foot, \$95 per base

4 SELECT HARDWARE

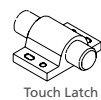

Touch Latch

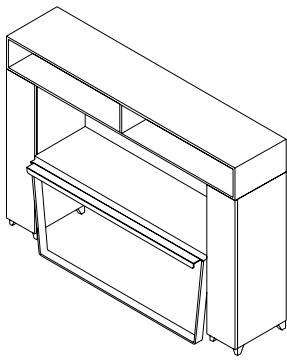

NOT SO SQUARE OPEN

STORAGE TOWER KITS - KIT #8

56" H BRIDGE UNIT, CONNECTING SURFACE, OVERHEAD W/ 1 SIDED ACCESS

STANDARD FEATURES

- NSS1018OP709 Wardrobe left hinge (1)
- NSS1018OP710 Wardrobe right hinge (1)
- NSS6118OP701 Connecting surface (1)
- NSS8118OP711 Overhead open storage - 1 sided access (1)
- ASB61DT Connecting Leg (1)
- Standard Silver Feet (optional White, Black)
- Touch latch

NOTES

- Clearance from connecting surface to bottom of overhead equals 19.25" height

[CLICK HERE TO VIEW PRODUCT INDEX](#)

1 SELECT A STYLE

DIMENSIONS		STYLE NUMBER	LIST PRICE	STYLE NUMBER	LIST PRICE	STYLE NUMBER	LIST PRICE	
W" x D" x H"	WGT	"W" Veneer Veneer Top Veneer Chassis		"G" HPL High Pressure Laminate Top Veneer Chassis		"M" TFL Thermally Fused Laminate Top Thermally Fused Laminate Chassis		
Wardrobe Left Hinge (1)								
10 x 18 x 48	75	"W" option N/A		"G" option N/A		NSS1018OP709M	772	
Wardrobe Right Hinge (1)								
10 x 18 x 48	75	"W" option N/A		"G" option N/A		NSS1018OP710M	772	
Overhead Open Storage - 1 Sided Access (1)								
81 x 18 x 10	100	"W" option N/A		"G" option N/A		NSS8118OP731M	688	
Connection Surface (1)								
61 x 18 x 1.125	45	"W" option N/A		"G" option N/A		NSS6118OP701M	383	
Connecting Leg								
61 x 3 x .5	90	"W" Option N/A		"G" Option N/A		ASB61DT	814	
						Kit #8	NSS81565T803	3429

2 SELECT A FINISH

"W" Veneer	"G" HPL	"M" TFL	
-	-	MHC	Honey Cherry
-	-	MOC	Koko Cherry
-	-	MGW	Gunstock Walnut
-	-	MTW	Studio Teak Walnut
-	-	MWL	Designer White
Metal Finishes			
MFB	-	-	Black (Premium Finish)
MFS	-	-	Silver
MFW	-	-	White (Premium Finish)

3 SELECT AN EDGE



Flat 2 mm

5 OPTIONS

LEGS

- D8: Delete Legs (extended fronts to the floor) - n/c

PREMIUM FINISH OPTION

- MFB: Black metal finish - \$25 per leg, \$95 per base
- MFW: White metal finish - \$25 per leg, \$95 per base

4 SELECT HARDWARE



Touch Latch

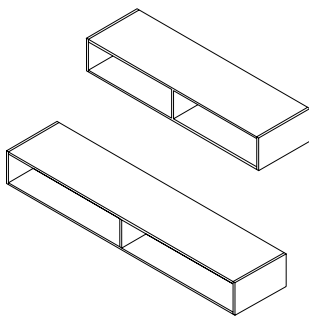

OVERHEAD OPEN STORAGE

STANDARD FEATURES

- 61" is to fit between two towers & 81" is to sit on top of two towers

NOTES

- Connecting Surface is used to span between towers.

[CLICK HERE TO VIEW PRODUCT INDEX](#)

1 SELECT A STYLE

DIMENSIONS		STYLE NUMBER	LIST PRICE	STYLE NUMBER	LIST PRICE	STYLE NUMBER	LIST PRICE
W" x D" x H"	WGT	"W" Veneer Top Veneer Chassis		"G" HPL High Pressure Laminate Top Veneer Chassis		"M" TFL Thermally Fused Laminate Top Thermally Fused Laminate Chassis	
Two Sided Access							
61 x 18 x 10	90	"W" option N/A		"G" option N/A		NSS6118OP711M	625
81 x 18 x 10	100	"W" option N/A		"G" option N/A		NSS8118OP711M	688
One Sided Access							
61 x 18 x 10	90	"W" option N/A		"G" option N/A		NSS6118OP731M	625
81 x 18 x 10	100	"W" option N/A		"G" option N/A		NSS8118OP731M	688

2 SELECT A FINISH **3 SELECT AN EDGE** **5 OPTIONS**

"W" Veneer	"G" HPL	"M" TFL	
-	-	MHC	Honey Cherry
-	-	MOC	Koko Cherry
-	-	MGW	Gunstock Walnut
-	-	MTW	Studio Teak Walnut
-	-	MWL	Designer White

Edge Profile
Option Not Available

4 SELECT HARDWARE

Hardware
Option Not Available

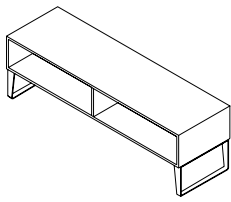

OVERHEAD STORAGE AND PRIVACY/ MODESTY PANELS

OVERHEAD STORAGE WITH METAL SUPPORT BASE

STANDARD FEATURES

- Overhead is secured to tops by bolts through the tops
- Overhead open storage supported by metal supports
- Standard Silver Base (optional White, Black)

[CLICK HERE TO VIEW PRODUCT INDEX](#)

1 SELECT A STYLE

DIMENSIONS		STYLE NUMBER	LIST PRICE	STYLE NUMBER	LIST PRICE	STYLE NUMBER	LIST PRICE
W" x D" x H"	WGT	"W" Veneer Top Veneer Chassis		"G" HPL High Pressure Laminate Top Veneer Chassis		"M" TFL Thermally Fused Laminate Top Thermally Fused Laminate Chassis	
Two sided access							
61 x 18 x 19	90	"W" option N/A		"G" option N/A		NSS6118OP732M	1150
One Sided Access							
61 x 18 x 19	90	"W" option N/A		"G" option N/A		NSS6118OP733M	1150

2 SELECT A FINISH

"W"	"G"	"M"	
Veneer	HPL	TFL	
-	-	MHC	Honey Cherry
-	-	MOC	Koko Cherry
-	-	MGW	Gunstock Walnut
-	-	MTW	Studio Teak Walnut
-	-	MWL	Designer White
Metal Finishes			
MFB	-	-	Black (Premium Finish)
MFS	-	-	Silver
MFW	-	-	White (Premium Finish)

3 SELECT AN EDGE

Edge Profile
Option Not Available

5 OPTIONS

PREMIUM FINISH OPTION
- MFB:Black metal finish - \$95 per base
- MFW: White metal finish - \$95 per base

4 SELECT HARDWARE

Hardware
Option Not Available

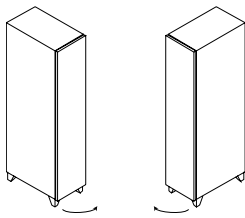

WARDROBES

STANDARD FEATURES

- Standard Silver Feet (optional White, Black)
- Touch latch

[CLICK HERE TO VIEW PRODUCT INDEX](#)

1 SELECT A STYLE

DIMENSIONS		STYLE NUMBER	LIST PRICE	STYLE NUMBER	LIST PRICE	STYLE NUMBER	LIST PRICE
W" x D" x H"	WGT	"W" Veneer Veneer Top Veneer Chassis		"G" HPL High Pressure Laminate Top Veneer Chassis		"M" TFL Thermally Fused Laminate Top Thermally Fused Laminate Chassis	
Left Hinge							
10 x 18 x 48	75	"W" option N/A		"G" option N/A		NSS1018OP709M	772
Right Hinge							
10 x 18 x 48	75	"W" option N/A		"G" option N/A		NSS1018OP710M	772

2 SELECT A FINISH

"W" Veneer	"G" HPL	"M" TFL	
-	-	MHC	Honey Cherry
-	-	MOC	Koko Cherry
-	-	MGW	Gunstock Walnut
-	-	MTW	Studio Teak Walnut
-	-	MWL	Designer White
Metal Finishes			
MFB	-	-	Black (Premium Finish)
MFS	-	-	Silver
MFW	-	-	White (Premium Finish)

3 SELECT AN EDGE

Edge Profile
Option Not Available

5 OPTIONS

- DOOR**
- D2: Door Lock - \$95 per Door
 - D9SC: Soft Close Door Hinges - \$15 per Door
- PREMIUM FINISH OPTION**
- MFB:Black metal finish - \$25 per foot
 - MFW: White metal finish - \$25 per foot

4 SELECT HARDWARE



Touch Latch

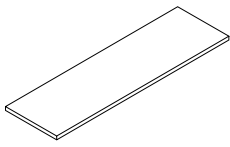

CONNECTING SURFACE

STANDARD FEATURES

- Joins two adjustable height mechs - 1.125 Inches thick melamine with PVC edge
- Work surface may be connected to end leg, middle leg, case and privacy end panel

NOTES

- Privacy cannot be used on 54" when using power trough

[CLICK HERE TO VIEW PRODUCT INDEX](#)

1 SELECT A STYLE

DIMENSIONS		STYLE NUMBER	LIST PRICE	STYLE NUMBER	LIST PRICE	STYLE NUMBER	LIST PRICE
W" x D" x H"	WGT	"W" Veneer Top Veneer Chassis		"G" HPL High Pressure Laminate Top Veneer Chassis		"M" TFL Thermally Fused Laminate Top Thermally Fused Laminate Chassis	
61 x 18 x 1.125	45	"W" option N/A		"G" option N/A		NSS6118OP701M	383

2 SELECT A FINISH

"W" Veneer	"G" HPL	"M" TFL	
-	-	MHC	Honey Cherry
-	-	MOC	Koko Cherry
-	-	MGW	Gunstock Walnut
-	-	MTW	Studio Teak Walnut
-	-	MWL	Designer White

3 SELECT AN EDGE



Flat 2 mm

5 OPTIONS

EXPOSED PLYWOOD EDGE

- WEPB: Exposed Plywood Edge w/ Baltic Birch Veneer - n/c
- Only available with WCF - Clear Coat Finish

4 SELECT HARDWARE

Hardware
Option Not
Available

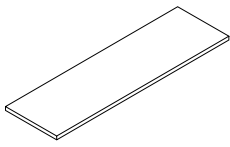

NOT SO SQUARE OPEN

A LA CARTE KIT ITEMS

CONNECTING SURFACE WITH EXPOSED PLYWOOD EDGE

STANDARD FEATURES

- 1.125" Tops w/ exposed plywood edge
- Work surface may be connected to end leg, middle leg, case and privacy end panel

NOTES

- Privacy cannot be used on 54" when using power trough

[CLICK HERE TO VIEW PRODUCT INDEX](#)

1 SELECT A STYLE

DIMENSIONS		STYLE NUMBER	LIST PRICE	STYLE NUMBER	LIST PRICE	STYLE NUMBER	LIST PRICE
W" x D" x H"	WGT	"W" Veneer Top Veneer Chassis		"G" HPL High Pressure Laminate Top Veneer Chassis		"M" TFL Thermally Fused Laminate Top Thermally Fused Laminate Chassis	
61 x 18 x 1.125	45	"W" option N/A		NSS6118OP801G	920	"M" option N/A	

2 SELECT A FINISH

"W" Veneer	"G" HPL	"M" TFL	
-	-	MHC	Honey Cherry
-	-	MOC	Koko Cherry
-	-	MGW	Gunstock Walnut
-	-	MTW	Studio Teak Walnut
-	-	MWL	Designer White

3 SELECT AN EDGE



Flat 2 mm

5 OPTIONS

- TOP**
- MMB: Markerboard Top - \$55
- EXPOSED PLYWOOD EDGE**
- WEPB: Exposed Plywood Edge w/ Baltic Birch Veneer - n/c
 - Only available with WCF - Clear Coat Finish

4 SELECT HARDWARE

Hardware
Option Not
Available

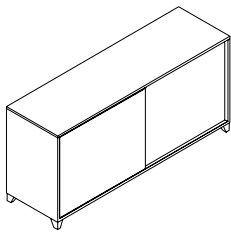

END CABINET / SLIDING DOOR

STANDARD FEATURES

- Adjustable finished shelf per door section
- Standard Silver Feet (optional White, Black)

[CLICK HERE TO VIEW PRODUCT INDEX](#)

1 SELECT A STYLE

DIMENSIONS		STYLE NUMBER	LIST PRICE	STYLE NUMBER	LIST PRICE	STYLE NUMBER	LIST PRICE
W" x D" x H"	WGT	"W" Veneer Top Veneer Chassis		"G" HPL High Pressure Laminate Top Veneer Chassis		"M" TFL Thermally Fused Laminate Top Thermally Fused Laminate Chassis	
61 x 18 x 28.875	205	"W" option N/A		"G" option N/A		NSS6118OP713M	1171

2 SELECT A FINISH

"W"	"G"	"M"	
Veneer	HPL	TFL	
-	-	MHC	Honey Cherry
-	-	MOC	Koko Cherry
-	-	MGW	Gunstock Walnut
-	-	MTW	Studio Teak Walnut
-	-	MWL	Designer White
Metal Finishes			
MFB	-	-	Black (Premium Finish)
MFS	-	-	Silver
MFW	-	-	White (Premium Finish)

3 SELECT AN EDGE



Flat 2 mm

5 OPTIONS

LEGS

- D8: Delete Legs (extended fronts to the floor) - n/c

PREMIUM FINISH OPTION

- MFB: Black metal finish - \$25 per foot
- MFW: White metal finish - \$25 per foot

4 SELECT HARDWARE

Hardware
Option Not
Available

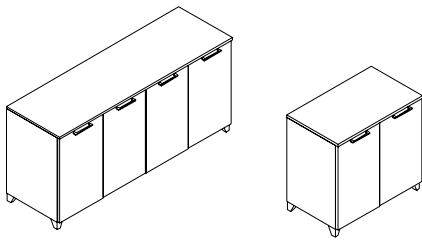

END CABINET / DOOR STORAGE

STANDARD FEATURES

- Adjustable finished shelf per door section
- Standard Silver Feet (optional White, Black)

[CLICK HERE TO VIEW PRODUCT INDEX](#)

1 SELECT A STYLE

DIMENSIONS		STYLE NUMBER	LIST PRICE	STYLE NUMBER	LIST PRICE	STYLE NUMBER	LIST PRICE
W" x D" x H"	WGT	"W" Veneer Veneer Top Veneer Chassis		"G" HPL High Pressure Laminate Top Veneer Chassis		"M" TFL Thermally Fused Laminate Top Thermally Fused Laminate Chassis	
4 Door							
61 x 18 x 28.875	210	"W" option N/A		"G" option N/A		NSS6118OP712M	1223
2 Door							
30 x 18 x 28.875	105	"W" option N/A		"G" option N/A		NSS3018OP712M	824

2 SELECT A FINISH

"W" Veneer	"G" HPL	"M" TFL	
-	-	MHC	Honey Cherry
-	-	MOC	Koko Cherry
-	-	MGW	Gunstock Walnut
-	-	MTW	Studio Teak Walnut
-	-	MWL	Designer White
Metal Finishes			
MFB	-	-	Black (Premium Finish)
MFS	-	-	Silver
MFW	-	-	White (Premium Finish)

3 SELECT AN EDGE



Flat 2 mm

5 OPTIONS

- DOOR**
- D7: Delete storage doors (pair) - Deduct \$100
 - D9SC: Soft Close Door Hinges - \$15 per Door
- LEGS**
- D8: Delete Legs (extended fronts to the floor) - n/c
- PREMIUM FINISH OPTION**
- MFB: Black metal finish - \$25 per foot
 - MFW: White metal finish - \$25 per foot

4 SELECT HARDWARE

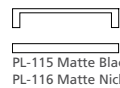

PL-115 Matte Black
PL-116 Matte Nickel

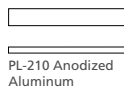

PL-210 Anodized Aluminum



PL-260 Anodized Aluminum
PL-261 White

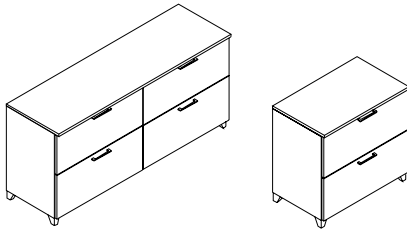

END CABINET / 2 DRAWER LATERAL FILE

STANDARD FEATURES

- File drawers extend 100% with cushion in-out stops - full access
- File drawers reinforced for heavy storage capacity
- Full extension drawers - locking
- Soft close suspension drawer(s)
- Standard Silver Feet (optional White, Black)

[CLICK HERE TO VIEW PRODUCT INDEX](#)

1 SELECT A STYLE

DIMENSIONS		STYLE NUMBER	LIST PRICE	STYLE NUMBER	LIST PRICE	STYLE NUMBER	LIST PRICE
W" x D" x H"	WGT	"W" Veneer Veneer Top Veneer Chassis		"G" HPL High Pressure Laminate Top Veneer Chassis		"M" TFL Thermally Fused Laminate Top Thermally Fused Laminate Chassis	
4 Drawer							
61 x 18 x 28.875	240	"W" option N/A		"G" option N/A		NSS6118OP714M	1670
2 Drawer							
30 x 18 x 28.875	120	"W" option N/A		"G" option N/A		NSS3018OP714M	1008

2 SELECT A FINISH

"W" Veneer	"G" HPL	"M" TFL	
-	-	MHC	Honey Cherry
-	-	MOC	Koko Cherry
-	-	MGW	Gunstock Walnut
-	-	MTW	Studio Teak Walnut
-	-	MWL	Designer White
Metal Finishes			
MFB	-	-	Black (Premium Finish)
MFS	-	-	Silver
MFW	-	-	White (Premium Finish)

3 SELECT AN EDGE



Flat 2 mm

5 OPTIONS

- DRAWER**
- P33: Wood Drawer Upgrade - \$40 per drawer
- LEGS**
- D8: Delete Legs (extended fronts to the floor) - n/c
- PREMIUM FINISH OPTION**
- MFB: Black metal finish - \$25 per foot
 - MFW: White metal finish - \$25 per foot

4 SELECT HARDWARE

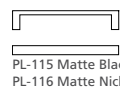

PL-115 Matte Black
PL-116 Matte Nickel

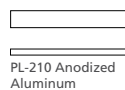

PL-210 Anodized Aluminum



PL-260 Anodized Aluminum
PL-261 White

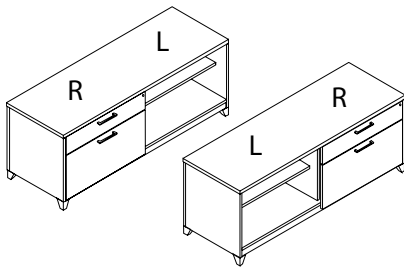

NOT SO SQUARE OPEN

BENCHES AND MOBILE PEDS

BENCHES - BOX/FILE STORAGE RIGHT AND LEFT

STANDARD FEATURES

- File drawers extend 100% with cushion in-out stops - full access
- File drawers reinforced for heavy storage capacity
- Full extension drawers - locking
- Soft close suspension drawer(s)
- Standard Silver Feet (optional White, Black)

work surface top - end leg must be specified
 - 58.5" W unit will receive a 29" W cushion and a 70.5" W unit will receive a 35" W cushion.

NOTES

- Specify bench runoff support when using w/

[CLICK HERE TO VIEW PRODUCT INDEX](#)

1 SELECT A STYLE

DIMENSIONS		STYLE NUMBER	LIST PRICE	STYLE NUMBER	LIST PRICE	STYLE NUMBER	LIST PRICE
W" x D" x H"	WGT	"W" Veneer Veneer Top Veneer Chassis		"G" HPL High Pressure Laminate Top Veneer Chassis		"M" TFL Thermally Fused Laminate Top Thermally Fused Laminate Chassis	
Left Box/File							
70.5 x 18 x 23	236	"W" option N/A		"G" option N/A		NSS7018CA065M	1473
58.5 x 18 x 23	210	"W" option N/A		"G" option N/A		NSS5818CA065M	1368
Right Box/File							
70.5 x 18 x 23	225	"W" option N/A		"G" option N/A		NSS7018CA064M	1473
58.5 x 18 x 23	210	"W" option N/A		"G" option N/A		NSS5818CA064M	1368

BC18 18" Depth Bench Cushion Option Graded Pricing

COM	COL	1	2	3	4	5	6	7	8	9	10	11/ L1	12	13/ L2
220	250	280	300	320	340	360	380	400	420	440	460	480	500	540

2 SELECT A FINISH

"W" Veneer	"G" HPL	"M" TFL	
-	-	MHC	Honey Cherry
-	-	MOC	Koko Cherry
-	-	MGW	Gunstock Walnut
-	-	MTW	Studio Teak Walnut
-	-	MWL	Designer White
Metal Finishes			
MFB	-	-	Black (Premium Finish)
MFS	-	-	Silver
MFW	-	-	White (Premium Finish)

3 SELECT AN EDGE



Flat 2 mm

5 OPTIONS

CUSHION

- Specify location, number of cushions and fabric grade.
- BC18: 18" Depth Bench Cushion

DRAWER

- P33: Wood Drawer Upgrade - \$40 per drawer

LEGS

- D8: Delete Legs (extended fronts to the floor) - n/c

SUPPORT

- 23BRT30: Bench Runoff Support - \$195

PREMIUM FINISH OPTION

- MFB: Black metal finish - \$25 per foot
- MFW: White metal finish - \$25 per foot

4 SELECT HARDWARE

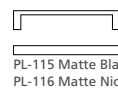

PL-115 Matte Black
PL-116 Matte Nickel

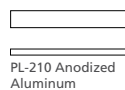

PL-210 Anodized Aluminum



PL-260 Anodized Aluminum
PL-261 White

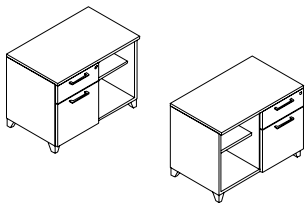

NOT SO SQUARE OPEN

BENCHES AND MOBILE PEDS

BENCHES - BOX FILE/STORAGE RIGHT AND LEFT

STANDARD FEATURES

- File drawers extend 100% with cushion in-out stops - full access
- File drawers reinforced for heavy storage capacity
- Full extension drawers - locking
- Soft close suspension drawer(s)
- Standard Silver Feet (optional White, Black)

work surface top - end leg must be specified

NOTES

- Specify bench runoff support when using w/

[CLICK HERE TO VIEW PRODUCT INDEX](#)

1 SELECT A STYLE

DIMENSIONS		STYLE NUMBER	LIST PRICE	STYLE NUMBER	LIST PRICE	STYLE NUMBER	LIST PRICE
W" x D" x H"	WGT	"W" Veneer Veneer Top Veneer Chassis		"G" HPL High Pressure Laminate Top Veneer Chassis		"M" TFL Thermally Fused Laminate Top Thermally Fused Laminate Chassis	
Left Box/File							
29 x 18 x 22	110	"W" option N/A		"G" option N/A		NSS2918OP707M	1045
Right Box/File							
29 x 18 x 22	110	"W" option N/A		"G" option N/A		NSS2918OP706M	1045

BC18 18" Depth Bench Cushion Option Graded Pricing

COM	COL	1	2	3	4	5	6	7	8	9	10	11/ L1	12	13/ L2
220	250	280	300	320	340	380	360	400	420	440	460	480	500	540

2 SELECT A FINISH

"W" Veneer	"G" HPL	"M" TFL	
-	-	MHC	Honey Cherry
-	-	MOC	Koko Cherry
-	-	MGW	Gunstock Walnut
-	-	MTW	Studio Teak Walnut
-	-	MWL	Designer White

3 SELECT AN EDGE



Flat 2 mm

5 OPTIONS

CUSHION

- Specify location, number of cushions and fabric grade.
- BC18: 18" Depth Bench Cushion

DRAWER

- P33: Wood Drawer Upgrade - \$40 per drawer

SUPPORT

- 23BRT30: Bench Runoff Support - \$195

PREMIUM FINISH OPTION

- MFB: Black metal finish - \$25 per foot
- MFW: White metal finish - \$25 per foot

4 SELECT HARDWARE



PL-115 Matte Black
PL-116 Matte Nickel



PL-210 Anodized
Aluminum



PL-260 Anodized Aluminum
PL-261 White

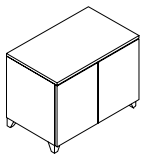

NOT SO SQUARE OPEN

BENCHES AND MOBILE PEDS

BENCHES - BENCHES TWO DOOR

STANDARD FEATURES

- Doors fully matched set
- Interior cabinet depth 16.5"
- Standard Silver Feet (optional White, Black)

[CLICK HERE TO VIEW PRODUCT INDEX](#)

1 SELECT A STYLE

DIMENSIONS		STYLE NUMBER	LIST PRICE	STYLE NUMBER	LIST PRICE	STYLE NUMBER	LIST PRICE
W" x D" x H"	WGT	"W" Veneer Top Veneer Chassis		"G" High Pressure Laminate Top HPL Veneer Chassis		"M" Thermally Fused Laminate Top TFL Thermally Fused Laminate Chassis	
29 x 18 x 22	100	"W" option N/A		"G" option N/A		NSS2918OP708M	956

BC18 18" Depth Bench Cushion Option Graded Pricing

COM	COL	1	2	3	4	5	6	7	8	9	10	11/ L1	12	13/ L2
240	270	300	320	340	360	380	400	420	440	460	480	500	520	560

2 SELECT A FINISH

"W" Veneer	"G" HPL	"M" TFL	
-	-	MHC	Honey Cherry
-	-	MOC	Koko Cherry
-	-	MGW	Gunstock Walnut
-	-	MTW	Studio Teak Walnut
-	-	MWL	Designer White
Metal Finishes			
MFB	-	-	Black (Premium Finish)
MFS	-	-	Silver
MFW	-	-	White (Premium Finish)

3 SELECT AN EDGE



Flat 2 mm

5 OPTIONS

CUSHION

- Specify location, number of cushions and fabric grade.
- BC18: 18" Depth Bench Cushion

DOOR

- D2: Door Lock - \$95 per Door
- D9SC: Soft Close Door Hinges - \$15 per Door

PREMIUM FINISH OPTION

- MFB: Black metal finish - \$25 per foot
- MFW: White metal finish - \$25 per foot

4 SELECT HARDWARE

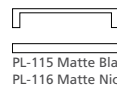

PL-115 Matte Black
PL-116 Matte Nickel

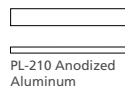

PL-210 Anodized
Aluminum



PL-260 Anodized Aluminum
PL-261 White

NOT SO SQUARE OPEN BENCHES AND MOBILE PEDS



Box/Box/File
PD424

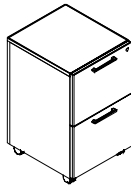

File/File
PD425

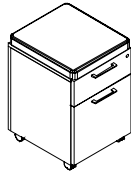

Box/File W/ BC18
Cushion Option
PD423

MOBILE PEDS - BOX BOX FILE LOCK, CASTERS

STANDARD FEATURES

- File drawers extend 100% with cushion in-out stops - full access
- File drawers reinforced for heavy storage capacity
- Full extension drawers - locking
- Locking black casters are standard
- Soft close suspension drawer(s)

[CLICK HERE TO VIEW PRODUCT INDEX](#)

1 SELECT A STYLE

DIMENSIONS		STYLE NUMBER	LIST PRICE	STYLE NUMBER	LIST PRICE	STYLE NUMBER	LIST PRICE
W" x D" x H"	WGT	"W" Veneer Veneer Top Veneer Chassis		"G" HPL High Pressure Laminate Top Veneer Chassis		"M" TFL Thermally Fused Laminate Top Thermally Fused Laminate Chassis	
16 x 18 x 27	90	"W" option N/A		"G" option N/A		NSS1618PD424M	1026
16 x 18 x 27	90	"W" option N/A		"G" option N/A		NSS1618PD425M	1026
16 x 18 x 24.5	80	"W" option N/A		"G" option N/A		NSS1618PD423M	770

BC18 18" Depth Bench Cushion Option Graded Pricing for PD423

COM	COL	1	2	3	4	5	6	7	8	9	10	11/ L1	12	13/ L2
215	N/A	245	260	275	290	305	320	335	350	365	380	395	410	425

2 SELECT A FINISH

"W" Veneer	"G" HPL	"M" TFL	
-	-	MHC	Honey Cherry
-	-	MOC	Koko Cherry
-	-	MGW	Gunstock Walnut
-	-	MTW	Studio Teak Walnut
-	-	MWL	Designer White
Metal Finishes			
MFB	-	-	Black (Premium Finish)
MFS	-	-	Silver
MFW	-	-	White (Premium Finish)

3 SELECT AN EDGE

Edge Profile
Option Not Available

5 OPTIONS

- CASTER**
- CST10: Silver caster upgrade - \$95
- CUSHION**
- Specify fabric grade
 - Cushion can only be added to PD423
 - BC18: 18" Depth Bench Cushion
- DRAWER**
- P33: Wood Drawer Upgrade - \$40 per drawer
- PREMIUM FINISH OPTION**
- MFB: Black metal finish - \$25 per foot
 - MFW: White metal finish - \$25 per foot

4 SELECT HARDWARE

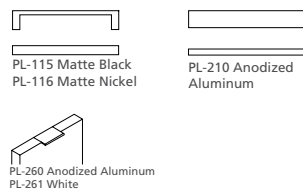

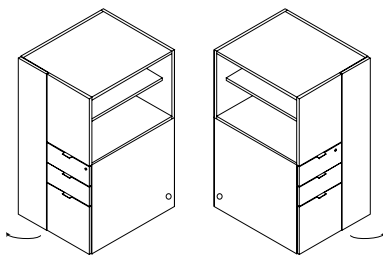

Hinged Left

Hinged Right

ALL-IN-ONE CABINET - LEFT AND RIGHT

STANDARD FEATURES

- 80mm grommet in side panel for daisy chain pass through
- Ball bearing suspension
- File drawers reinforced for heavy storage capacity
- Full extension drawers - locking
- Soft close suspension drawer(s)
- Two units are offered that allows for additional storage away from the work surface - Door Unit and File Unit

- Wardrobes have hanging bar and touch latch doors

[CLICK HERE TO VIEW PRODUCT INDEX](#)

1 SELECT A STYLE

DIMENSIONS		STYLE NUMBER	LIST PRICE	STYLE NUMBER	LIST PRICE	STYLE NUMBER	LIST PRICE
W" x D" x H"	WGT	"W" Veneer Veneer Top Veneer Chassis		"G" HPL High Pressure Laminate Top Veneer Chassis		"M" TFL Thermally Fused Laminate Top Thermally Fused Laminate Chassis	
Left Hinge Wardrobe / Right B/B/F							
26 x 30 x 48	250	"W" option N/A		"G" option N/A		NSS3048OP704M	1460
Right Hinge Wardrobe / Left B/B/F							
26 x 30 x 48	250	"W" option N/A		"G" option N/A		NSS3048OP705M	1460

2 SELECT A FINISH

"W" Veneer	"G" HPL	"M" TFL	
-	-	MHC	Honey Cherry
-	-	MOC	Koko Cherry
-	-	MGW	Gunstock Walnut
-	-	MTW	Studio Teak Walnut
-	-	MWL	Designer White

3 SELECT AN EDGE

Edge Profile
Option Not Available

5 OPTIONS

DOOR
- D9SC: Soft Close Door Hinges - \$15 per Door

4 SELECT HARDWARE

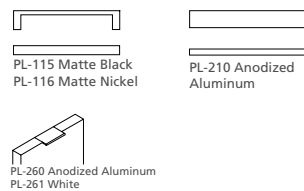

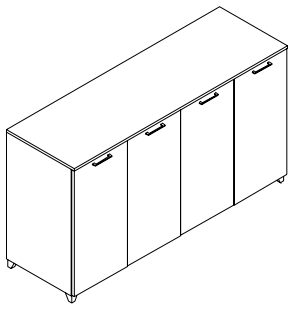

NOT SO SQUARE OPEN

SHARED STORAGE

SHARED DOOR STORAGE

STANDARD FEATURES

- Hardware available in black, silver, or white
- Sections standard w/ adjustable shelf
- Standard Silver Feet (optional White, Black)

vertical section will be removed when this option is ordered so most small refrigerators will fit within this space - please check dimensions with factory

NOTES

- TRC230 2 -30 GAL trash cans on pull-out shelf
- Interior dimensions of storage area: 36" H, 22" D, 17.75" W
- REF-02 REFRIGERATOR INSERT with rubber mat, heat vent and grommet hole (Note: center

[CLICK HERE TO VIEW PRODUCT INDEX](#)

1 SELECT A STYLE

DIMENSIONS		STYLE NUMBER	LIST PRICE	STYLE NUMBER	LIST PRICE	STYLE NUMBER	LIST PRICE
W" x D" x H"	WGT	"W" Veneer Top Veneer Chassis		"G" High Pressure Laminate Top HPL Veneer Chassis		"M" Thermally Fused Laminate Top TFL Thermally Fused Laminate Chassis	
75.5 x 24 x 42	320	"W" option N/A		"G" option N/A		NSS7524OP724M	2216

2 SELECT A FINISH

"W" Veneer	"G" HPL	"M" TFL	Finish
-	-	MHC	Honey Cherry
-	-	MOC	Koko Cherry
-	-	MGW	Gunstock Walnut
-	-	MTW	Studio Teak Walnut
-	-	MWL	Designer White
Metal Finishes			
MFB	-	-	Black (Premium Finish)
MFS	-	-	Silver
MFW	-	-	White (Premium Finish)

3 SELECT AN EDGE



5 OPTIONS

DOOR

- D9SC: Soft Close Door Hinges - \$15 per Door

REFRIGERATOR

- REF-02: Refrigerator Insert Kit - \$210
- Specify left or right location

TRASH CAN

- TRC230: Trash Can Insert - (2) 30 gal containers - \$475
- Specify left or right location

PREMIUM FINISH OPTION

- MFB: Black metal finish - \$25 per foot
- MFW: White metal finish - \$25 per foot

4 SELECT HARDWARE



PL-115 Matte Black
PL-116 Matte Nickel

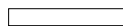

PL-210 Anodized Aluminum



PL-260 Anodized Aluminum
PL-261 White

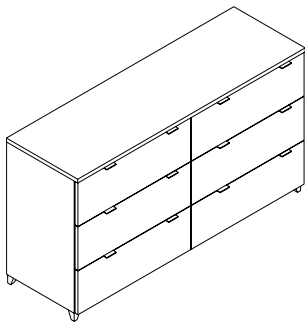

SHARED FILE STORAGE

STANDARD FEATURES

- File drawers reinforced for heavy storage capacity
- Full extension drawers - locking
- Hardware available in black, silver, or white
- Soft close suspension drawer(s)
- Standard Silver Feet (optional White, Black)

[CLICK HERE TO VIEW PRODUCT INDEX](#)

1 SELECT A STYLE

DIMENSIONS		STYLE NUMBER	LIST PRICE	STYLE NUMBER	LIST PRICE	STYLE NUMBER	LIST PRICE
W" x D" x H"	WGT	"W" Veneer Top Veneer Chassis		"G" High Pressure Laminate Top HPL Veneer Chassis		"M" Thermally Fused Laminate Top TFL Thermally Fused Laminate Chassis	
75.5 x 24 x 42	500	"W" option N/A		"G" option N/A		NSS7524OP725M	3260

2 SELECT A FINISH

"W"	"G"	"M"	
Veneer	HPL	TFL	
-	-	MHC	Honey Cherry
-	-	MOC	Koko Cherry
-	-	MGW	Gunstock Walnut
-	-	MTW	Studio Teak Walnut
-	-	MWL	Designer White
Metal Finishes			
MFB	-	-	Black (Premium Finish)
MFS	-	-	Silver
MFW	-	-	White (Premium Finish)

3 SELECT AN EDGE



5 OPTIONS

- DRAWER**
- P33: Wood Drawer Upgrade - \$40 per drawer
- LEGS**
- D8: Delete Legs (extended fronts to the floor) - n/c
- PREMIUM FINISH OPTION**
- MFB: Black metal finish - \$25 per foot
 - MFW: White metal finish - \$25 per foot

4 SELECT HARDWARE

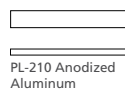
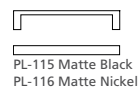

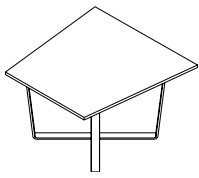

NOT SO SQUARE TABLE

STANDARD FEATURES

- A power port or a marker cup may be ordered to go in center of table which included cut out as shown
- Standard Silver Base (optional White, Black)
- Table top is standard with TFL laminate
- Tops may also be ordered in white marker board

tops together)

NOTES

- TCON Table Connector (Use when connecting 2

[CLICK HERE TO VIEW PRODUCT INDEX](#)

1 SELECT A STYLE

DIMENSIONS		STYLE NUMBER	LIST PRICE	STYLE NUMBER	LIST PRICE	STYLE NUMBER	LIST PRICE
W" x D" x H"	WGT	"W" Veneer Top Veneer Chassis		"G" HPL High Pressure Laminate Top Veneer Chassis		"M" TFL Thermally Fused Laminate Top Thermally Fused Laminate Chassis	
Marker Board Top							
36 x 36 x 22	60	"W" option N/A		"G" option N/A		NSS3636OP722M	1297
Thermally Fused Laminate Top							
36 x 36 x 22	60	"W" option N/A		"G" option N/A		NSS3636OP723M	1139

2 SELECT A FINISH

"W"	"G"	"M"	
Veneer	HPL	TFL	
-	-	MHC	Honey Cherry
-	-	MOC	Koko Cherry
-	-	MGW	Gunstock Walnut
-	-	MTW	Studio Teak Walnut
-	-	MWL	Designer White
Metal Finishes			
MFB	-	-	Black (Premium Finish)
MFS	-	-	Silver
MFW	-	-	White (Premium Finish)

3 SELECT AN EDGE

Edge Profile
Option Not Available

5 OPTIONS

ACCESSORIES

- MC-730: Marker Cup - \$65
- PD-COVE-RD: Round Power Unit (White) - \$475 (Includes 1 Power, 2 USB)
- TCON: Table Connector to connect tables - \$40

PREMIUM FINISH OPTION

- MFB: Black metal finish - \$95 per base
- MFW: White metal finish - \$95 per base

4 SELECT HARDWARE

Hardware
Option Not Available

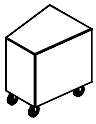

NOT SO SQUARE STOOL

STANDARD FEATURES

- Angular shape that corresponds w/ Not So
- Square table top
- Clear casters

[CLICK HERE TO VIEW PRODUCT INDEX](#)

1 SELECT A STYLE

DIMENSIONS		STYLE NUMBER	LIST PRICE	STYLE NUMBER	LIST PRICE	STYLE NUMBER	LIST PRICE
W" x D" x H"	WGT	"S" Seating					
15 x 18 x 18.5	20	NSS1518OP723	649 COM				
2 yd required							

COM	COL	1	2	3	4	5	6	7	8	9	10	11/ L1	12	13/ L2
649	677	760	797	834	871	908	945	982	1019	1056	1093	1130	1167	1241

2 SELECT A FINISH

"S"
Seating

3 SELECT AN EDGE

Edge Profile
Option Not
Available

5 OPTIONS

No Options Available

4 SELECT HARDWARE

Hardware
Option Not
Available

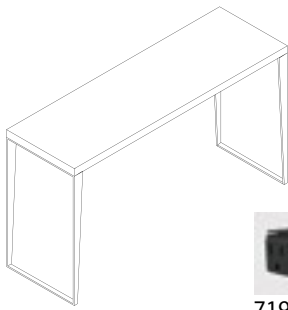

719PP OPTION

BAR HEIGHT TABLE

STANDARD FEATURES

- No shiny laminates can be used
- Standard Silver Base (optional White, Black)
- Tops are only available in DARRAN standard HPL
- Tops may be ganged lengthwise together
- Two standard lengths and one standard width offered

[CLICK HERE TO VIEW PRODUCT INDEX](#)

1 SELECT A STYLE

DIMENSIONS		STYLE NUMBER	LIST PRICE	STYLE NUMBER	LIST PRICE	STYLE NUMBER	LIST PRICE
W" x D" x H"	WGT	"W" Veneer Top Veneer Chassis		"G" HPL High Pressure Laminate Top Veneer Chassis		"M" TFL Thermally Fused Laminate Top Thermally Fused Laminate Chassis	
75.5 x 24 x 42		"W" option N/A		NSS7624OP719	2426	"M" option N/A	
50.5 x 24 x 42		"W" option N/A		NSS5124OP719	2237	"M" option N/A	

2 SELECT A FINISH

"W" Veneer	"G" HPL	"M" TFL	
-	GHC	-	Honey Cherry
-	GOC	-	Koko Cherry
-	GWC	-	Wheat Cherry
-	GCM	-	Clear Maple
-	GEW	-	Executive Walnut
-	GGW	-	Gunstock Walnut
-	GTW	-	Studio Teak Walnut
-	GWL	-	Designer White
Metal Finishes			
MFB	-	-	Black (Premium Finish)
MFS	-	-	Silver
MFW	-	-	White (Premium Finish)

3 SELECT AN EDGE



Flat 2 mm

4 SELECT HARDWARE

Hardware
Option Not
Available

5 OPTIONS

- ACCESSORIES**
- 719WM: Wire Manager for Stand Up Table - \$65
 - 719PP: Power Pod - 2 Plug (Black) - \$120
- PREMIUM FINISH OPTION**
- MFB: Black metal finish - \$95 per base
 - MFW: White metal finish - \$95 per base

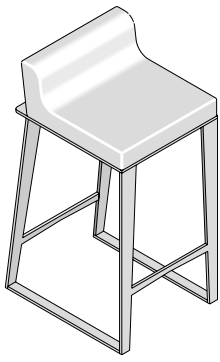

NOT SO SQUARE OPEN BAR HEIGHT TABLE AND BAR STOOLS

SHORT BACK BAR STOOL

STANDARD FEATURES

- A special sewing technique is available "rail" tufting at an upcharge with a longer lead time
- Bar Stools have nylon protectors on foot rails and glides
- Standard Silver Base (optional White, Black)

[CLICK HERE TO VIEW PRODUCT INDEX](#)

1 SELECT A STYLE

DIMENSIONS		STYLE NUMBER	LIST PRICE	STYLE NUMBER	LIST PRICE	STYLE NUMBER	LIST PRICE
W" x D" x H"	WGT	"S" Seating					
16 x 16 x 30	30	NSS3016OP720	1138 COM				
1.25 yd required							

COM	COL	1	2	3	4	5	6	7	8	9	10	11/ L1	12	13/ L2
1138	1162	1207	1230	1253	1276	1299	1322	1345	1368	1391	1414	1437	1460	1506

2 SELECT A FINISH

"S" Seating	MFB	MFS	MFW	Finish
	-	-		Black (Premium Finish)
	-	-		Silver
	-	-		White (Premium Finish)

3 SELECT AN EDGE

Edge Profile
Option Not Available

5 OPTIONS

- TUFTING**
- RT01: Rail Tuft - \$205
 - Yardage required will increase to 1.75 yards
- PREMIUM FINISH OPTION**
- MFB: Black metal finish - \$95 per base
 - MFW: White metal finish - \$95 per base

4 SELECT HARDWARE

Hardware
Option Not Available

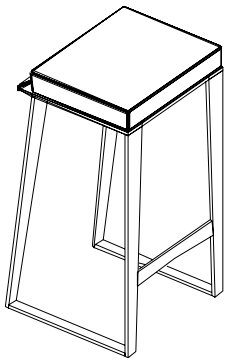

NOT SO SQUARE OPEN BAR HEIGHT TABLE AND BAR STOOLS

BACKLESS BAR STOOL

STANDARD FEATURES

- A special sewing technique is available "rail" tufting at an upcharge with a longer lead time
- Bar Stools have nylon protectors on foot rails and glides
- Standard Silver Base (optional White, Black)

[CLICK HERE TO VIEW PRODUCT INDEX](#)

1 SELECT A STYLE

DIMENSIONS		STYLE NUMBER	LIST PRICE	STYLE NUMBER	LIST PRICE	STYLE NUMBER	LIST PRICE
W" x D" x H"	WGT	"S" Seating					
16 x 16 x 30	30	NSS3016OP721	1029 COM				
1 yd required							

COM	COL	1	2	3	4	5	6	7	8	9	10	11/ L1	12	13/ L2
1029	1051	1084	1102	1120	1138	1156	1174	1192	1210	1228	1246	1264	1282	1318

2 SELECT A FINISH

"S" Seating	MFB	MFS	MFW	Finish
	-	-		Black (Premium Finish)
	-	-		Silver
	-	-		White (Premium Finish)

3 SELECT AN EDGE

Edge Profile
Option Not Available

5 OPTIONS

- TUFTING**
- RT01: Rail Tuft - \$150
 - Yardage required will increase to 1.75 yards
- PREMIUM FINISH OPTION**
- MFB: Black metal finish - \$95 per base
 - MFW: White metal finish - \$95 per base

4 SELECT HARDWARE

Hardware
Option Not Available

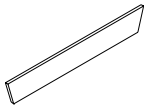

OVERHEAD STORAGE AND PRIVACY/ MODESTY PANELS

FABRIC PRIVACY / MODESTY TACK PANELS

STANDARD FEATURES

- Privacy panel will be hung from overhead unit with brackets between workstations

NOTES

- Only with provided brackets
- Tackboards are not available in COL, Leather or Vinyl materials. FABRIC ONLY

[CLICK HERE TO VIEW PRODUCT INDEX](#)

1 SELECT A STYLE

DIMENSIONS		STYLE NUMBER	LIST PRICE	STYLE NUMBER	LIST PRICE	STYLE NUMBER	LIST PRICE
W" x D" x H"	WGT	"C" Comp Component					
Mounted to Overhead Units							
48 x .875 x 7	14	NSS4807OP718	275 COM				
1.5 yd required							
27 Square Feet							

NSS4807OP718 Graded in Pricing

COM	COL	1	2	3	4	5	6	7	8	9	10	11/ L1	12	13/ L2
275	N/A	335	345	355	365	375	385	395	405	415	425	435	445	465

2 SELECT A FINISH

"C" Comp
Finishes N/A

3 SELECT AN EDGE

Edge Profile
Option Not Available

5 OPTIONS

No Options Available

4 SELECT HARDWARE

Hardware
Option Not Available

NOT SO SQUARE OPEN FABRIC PRIVACY TACK PANELS

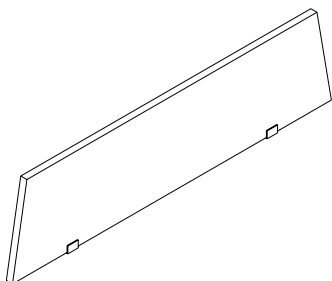

18" HIGH FABRIC PANELS

STANDARD FEATURES

- Fabric tack panels are double sided with angled sides
- Panels are mounted between desks
- Specify one for each adjustable table top
- Specify only one between two stationary desks
- Specify panel that fits work surface top size

- Tackboards are not available in COL, Leather or Vinyl materials. FABRIC ONLY

NOTES

- Gives Privacy Approximately 18" Above Work surface Only

[CLICK HERE TO VIEW PRODUCT INDEX](#)

1 SELECT A STYLE

DIMENSIONS		STYLE NUMBER	LIST PRICE	STYLE NUMBER	LIST PRICE	STYLE NUMBER	LIST PRICE
W" x D" x H"	WGT	"C" Component					
For 72" Work surfaces							
48 x .875 x 18	7	NSS4818OP718	See COM/ COL				
1.5 yd required							
27 Square Feet							

NSS4812OP718 Graded in Pricing

COM	COL	1	2	3	4	5	6	7	8	9	10	11/ L1	12	13/ L2
285	N/A	380	410	440	470	500	530	560	590	620	650	680	710	770

2 SELECT A FINISH

"C"
Comp
Finishes N/A

3 SELECT AN EDGE

Edge Profile
Option Not
Available

5 OPTIONS

No Options Available

4 SELECT HARDWARE

Hardware
Option Not
Available

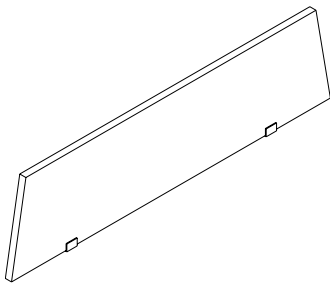

NOT SO SQUARE OPEN FABRIC PRIVACY TACK PANELS

18" HIGH FABRIC PANELS

STANDARD FEATURES

- Fabric tack panels are double sided with angled sides
- Panels are mounted between desks
- Specify one for each adjustable table top
- Specify only one between two stationary desks
- Specify panel that fits work surface top size

- Tackboards are not available in COL, Leather or Vinyl materials. FABRIC ONLY

NOTES

- Gives Privacy Approximately 18" Above Work surface Only

[CLICK HERE TO VIEW PRODUCT INDEX](#)

1 SELECT A STYLE

DIMENSIONS		STYLE NUMBER	LIST PRICE	STYLE NUMBER	LIST PRICE	STYLE NUMBER	LIST PRICE
W" x D" x H"	WGT	"C" Comp Component					
For 60" or 66" Work surfaces							
41 x .875 x 18	6	NSS4118OP718	See COM/ COL				
1.25 yd required							
22.5 Square Feet							

NSS4112OP718 Graded in Pricing

COM	COL	1	2	3	4	5	6	7	8	9	10	11/ L1	12	13/ L2
280	N/A	370	395	420	445	470	495	520	545	570	595	620	645	695

2 SELECT A FINISH

"C"
Comp
Finishes N/A

3 SELECT AN EDGE

Edge Profile
Option Not
Available

5 OPTIONS

No Options Available

4 SELECT HARDWARE

Hardware
Option Not
Available

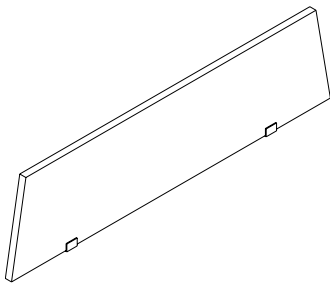

NOT SO SQUARE OPEN FABRIC PRIVACY TACK PANELS

18" HIGH FABRIC PANELS

STANDARD FEATURES

- Fabric tack panels are double sided with angled sides
- Panels are mounted between desks
- Specify one for each adjustable table top
- Specify only one between two stationary desks
- Specify panel that fits work surface top size

- Tackboards are not available in COL, Leather or Vinyl materials. FABRIC ONLY

NOTES

- Gives Privacy Approximately 18" Above Work surface Only

[CLICK HERE TO VIEW PRODUCT INDEX](#)

1 SELECT A STYLE

DIMENSIONS		STYLE NUMBER	LIST PRICE	STYLE NUMBER	LIST PRICE	STYLE NUMBER	LIST PRICE
W" x D" x H"	WGT	"C" Component					
For 54" Work surfaces							
30 x .875 x 18	14	NSS3018OP718	See COM/ COL				
1 yd required							
18 Square Feet							

NSS3012OP718 Graded in Pricing

COM	COL	1	2	3	4	5	6	7	8	9	10	11/ L1	12	13/ L2
270	N/A	350	365	380	395	410	425	440	455	470	485	500	515	545

2 SELECT A FINISH

"C"
Comp
Finishes N/A

3 SELECT AN EDGE

Edge Profile
Option Not
Available

5 OPTIONS

No Options Available

4 SELECT HARDWARE

Hardware
Option Not
Available

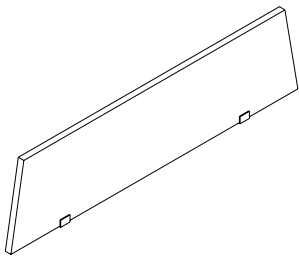

NOT SO SQUARE OPEN FABRIC PRIVACY TACK PANELS

12" HIGH FABRIC PANELS

STANDARD FEATURES

- Fabric tack panels are double sided with angled sides
- Panels are mounted between desks
- Specify one for each adjustable table top
- Specify only one between two stationary desks
- Specify panel that fits work surface top size

- Tackboards are not available in COL, Leather or Vinyl materials. FABRIC ONLY

NOTES

- Gives Privacy Approximately 12" Above Work surface Only

[CLICK HERE TO VIEW PRODUCT INDEX](#)

1 SELECT A STYLE

DIMENSIONS		STYLE NUMBER	LIST PRICE	STYLE NUMBER	LIST PRICE	STYLE NUMBER	LIST PRICE
W" x D" x H"	WGT	"C" Component					
For 72" Work surfaces							
48 x .875 x 12	7	NSS4812OP718	See COM/ COL				
1.5 yd required							
27 Square Feet							

NSS4812OP718 Graded in Pricing

COM	COL	1	2	3	4	5	6	7	8	9	10	11/ L1	12	13/ L2
285	N/A	380	410	440	470	500	530	560	590	620	650	680	710	770

2 SELECT A FINISH

"C"
Comp
Finishes N/A

3 SELECT AN EDGE

Edge Profile
Option Not
Available

5 OPTIONS

No Options Available

4 SELECT HARDWARE

Hardware
Option Not
Available

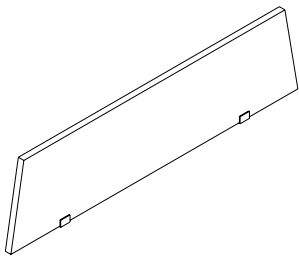

NOT SO SQUARE OPEN FABRIC PRIVACY TACK PANELS

12" HIGH FABRIC PANELS

STANDARD FEATURES

- Fabric tack panels are double sided with angled sides
- Panels are mounted between desks
- Specify one for each adjustable table top
- Specify only one between two stationary desks
- Specify panel that fits work surface top size

- Tackboards are not available in COL, Leather or Vinyl materials. FABRIC ONLY

NOTES

- Gives Privacy Approximately 12" Above Work surface Only

[CLICK HERE TO VIEW PRODUCT INDEX](#)

1 SELECT A STYLE

DIMENSIONS		STYLE NUMBER	LIST PRICE	STYLE NUMBER	LIST PRICE	STYLE NUMBER	LIST PRICE
W" x D" x H"	WGT	"C" Comp Component					
For 60" or 66" Work surfaces							
41 x .875 x 12	6	NSS4112OP718	See COM/ COL				
1.25 yd required							
22.5 Square Feet							

NSS4112OP718 Graded in Pricing

COM	COL	1	2	3	4	5	6	7	8	9	10	11/ L1	12	13/ L2
280	N/A	370	395	420	445	470	495	520	545	570	595	620	645	695

2 SELECT A FINISH 3 SELECT AN EDGE 5 OPTIONS

"C"
Comp
Finishes N/A

Edge Profile
Option Not
Available

No Options Available

4 SELECT HARDWARE

Hardware
Option Not
Available

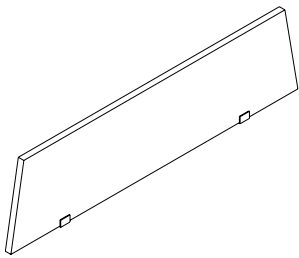

NOT SO SQUARE OPEN FABRIC PRIVACY TACK PANELS

12" HIGH FABRIC PANELS

STANDARD FEATURES

- Fabric tack panels are double sided with angled sides
- Panels are mounted between desks
- Specify one for each adjustable table top
- Specify only one between two stationary desks
- Specify panel that fits work surface top size

- Tackboards are not available in COL, Leather or Vinyl materials. FABRIC ONLY

NOTES

- Gives Privacy Approximately 12" Above Work surface Only

[CLICK HERE TO VIEW PRODUCT INDEX](#)

1 SELECT A STYLE

DIMENSIONS		STYLE NUMBER	LIST PRICE	STYLE NUMBER	LIST PRICE	STYLE NUMBER	LIST PRICE
W" x D" x H"	WGT	"C" Component					
For 54" Work surfaces							
30 x .875 x 12	14	NSS3012OP718	See COM/ COL				
1 yd required							
18 Square Feet							

NSS3012OP718 Graded in Pricing

COM	COL	1	2	3	4	5	6	7	8	9	10	11/ L1	12	13/ L2
270	N/A	350	365	380	395	410	425	440	455	470	485	500	515	545

2 SELECT A FINISH 3 SELECT AN EDGE 5 OPTIONS

"C"
Comp
Finishes N/A

Edge Profile
Option Not
Available

No Options Available

4 SELECT HARDWARE

Hardware
Option Not
Available

FABRIC PRIVACY AND MODESTY TACK PANELS

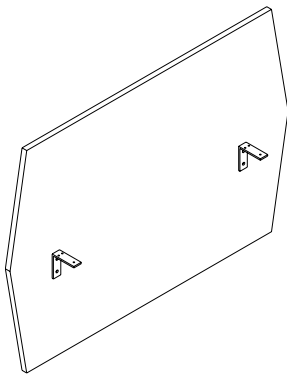

36" HIGH FABRIC PANELS

STANDARD FEATURES

- Fabric tack panels are double sided with angled sides
- Panels are mounted between desks
- Specify one for each adjustable table top
- Specify only one between two stationary desks
- Specify panel that fits work surface top size

- Tackboards are not available in COL, Leather or Vinyl materials. FABRIC ONLY

NOTES

- Gives Privacy Approximately 18" Above And 18" Below Work surface

[CLICK HERE TO VIEW PRODUCT INDEX](#)

1 SELECT A STYLE

DIMENSIONS		STYLE NUMBER	LIST PRICE	STYLE NUMBER	LIST PRICE	STYLE NUMBER	LIST PRICE
W" x D" x H"	WGT	"C" Component					
For 72" Work surfaces							
48 x .875 x 36	21	NSS4836OP718	See COM/ COL				
3 yd required							
54 Square Feet							

NSS4836OP718

COM	COL	1	2	3	4	5	6	7	8	9	10	11/ L1	12	13/ L2
370	N/A	530	590	650	710	770	830	890	950	1010	1070	1130	1190	1310

2 SELECT A FINISH **3 SELECT AN EDGE** **5 OPTIONS**

"C" Comp
Finishes N/A

Edge Profile
Option Not Available

No Options Available

4 SELECT HARDWARE

Hardware
Option Not Available

FABRIC PRIVACY AND MODESTY TACK PANELS

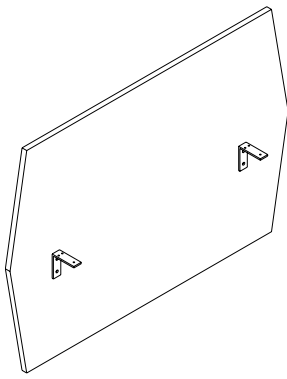

36" HIGH FABRIC PANELS

STANDARD FEATURES

- Fabric tack panels are double sided with angled sides
- Panels are mounted between desks
- Specify one for each adjustable table top
- Specify only one between two stationary desks
- Specify panel that fits work surface top size

- Tackboards are not available in COL, Leather or Vinyl materials. FABRIC ONLY

NOTES

- Gives Privacy Approximately 18" Above And 18" Below Work surface

[CLICK HERE TO VIEW PRODUCT INDEX](#)

1 SELECT A STYLE

DIMENSIONS		STYLE NUMBER	LIST PRICE	STYLE NUMBER	LIST PRICE	STYLE NUMBER	LIST PRICE
W" x D" x H"	WGT	"C" Comp Component					
For 60" or 66" Work surfaces							
41 x .875 x 36	19	NSS4136OP718	See COM/ COL				
2.5 yd required							
45 Square Feet							

NSS4136OP718 Graded in Pricing

COM	COL	1	2	3	4	5	6	7	8	9	10	11/ L1	12	13/ L2
350	N/A	500	555	610	665	720	775	830	885	940	995	1050	1105	1215

2 SELECT A FINISH 3 SELECT AN EDGE 5 OPTIONS

"C" Comp
Finishes N/A

Edge Profile
Option Not Available

No Options Available

4 SELECT HARDWARE

Hardware
Option Not Available

FABRIC PRIVACY AND MODESTY TACK PANELS

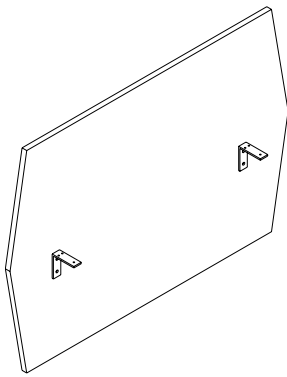

36" HIGH FABRIC PANELS

STANDARD FEATURES

- Fabric tack panels are double sided with angled sides
- Panels are mounted between desks
- Specify one for each adjustable table top
- Specify only one between two stationary desks
- Specify panel that fits work surface top size

- Tackboards are not available in COL, Leather or Vinyl materials. FABRIC ONLY

NOTES

- Gives Privacy Approximately 18" Above And 18" Below Work surface

[CLICK HERE TO VIEW PRODUCT INDEX](#)

1 SELECT A STYLE

DIMENSIONS		STYLE NUMBER	LIST PRICE	STYLE NUMBER	LIST PRICE	STYLE NUMBER	LIST PRICE
W" x D" x H"	WGT	"C" Component					
For 54" Work surfaces							
30 x .875 x 36	15	NSS3036OP718	See COM/ COL				
2 yd required							
36 Square Feet							

NSS3036OP718 Graded in Pricing

COM	COL	1	2	3	4	5	6	7	8	9	10	11/ L1	12	13/ L2
310	N/A	440	485	530	575	620	665	710	755	800	845	890	935	1025

2 SELECT A FINISH **3 SELECT AN EDGE** **5 OPTIONS**

"C" Comp
Finishes N/A

Edge Profile
Option Not Available

No Options Available

4 SELECT HARDWARE

Hardware
Option Not Available

FABRIC PRIVACY AND MODESTY TACK PANELS

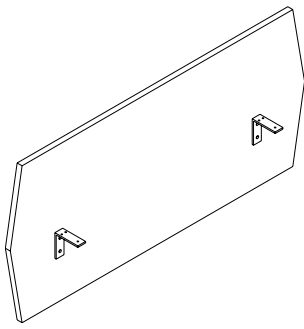

24" HIGH FABRIC PANELS

STANDARD FEATURES

- Fabric tack panels are double sided with angled sides
- Panels are mounted between desks
- Specify one for each adjustable table top
- Specify only one between two stationary desks
- Specify panel that fits work surface top size

- Tackboards are not available in COL, Leather or Vinyl materials. FABRIC ONLY

NOTES

- Gives Privacy Approximately 12" Above And 12" Below Work surface

[CLICK HERE TO VIEW PRODUCT INDEX](#)

1 SELECT A STYLE

DIMENSIONS		STYLE NUMBER	LIST PRICE	STYLE NUMBER	LIST PRICE	STYLE NUMBER	LIST PRICE
W" x D" x H"	WGT	"C" Component					
For 72" Work surfaces							
48 x .875 x 24	14	NSS4824OP718	See COM/ COL				
1.5 yd required							
27 Square Feet							

NSS4824OP718 Graded in Pricing

COM	COL	1	2	3	4	5	6	7	8	9	10	11/ L1	12	13/ L2
320	N/A	460	510	560	610	660	710	760	810	860	910	960	1010	1110

2 SELECT A FINISH **3 SELECT AN EDGE** **5 OPTIONS**

"C"
Comp
Finishes N/A

Edge Profile
Option Not Available

No Options Available

4 SELECT HARDWARE

Hardware
Option Not Available

FABRIC PRIVACY AND MODESTY TACK PANELS

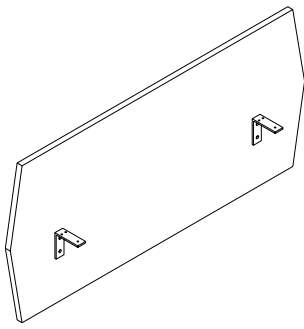

24" HIGH FABRIC PANELS

STANDARD FEATURES

- Fabric tack panels are double sided with angled sides
- Panels are mounted between desks
- Specify one for each adjustable table top
- Specify only one between two stationary desks
- Specify panel that fits work surface top size

- Tackboards are not available in COL, Leather or Vinyl materials. FABRIC ONLY

NOTES

- Gives Privacy Approximately 12" Above And 12" Below Work surface

[CLICK HERE TO VIEW PRODUCT INDEX](#)

1 SELECT A STYLE

DIMENSIONS		STYLE NUMBER	LIST PRICE	STYLE NUMBER	LIST PRICE	STYLE NUMBER	LIST PRICE
W" x D" x H"	WGT	"C" Comp Component					
For 60" or 66" Work surfaces							
41 x .875 x 24	12	NSS4124OP718	See COM/ COL				
1.25 yd required							
22.5 Square Feet							

NSS4124OP718 Graded in Pricing

COM	COL	1	2	3	4	5	6	7	8	9	10	11/ L1	12	13/ L2
315	N/A	445	490	535	580	625	670	715	760	805	850	895	940	1030

2 SELECT A FINISH **3 SELECT AN EDGE** **5 OPTIONS**

"C" Comp Finishes N/A

Edge Profile Option Not Available

No Options Available

4 SELECT HARDWARE

Hardware Option Not Available

FABRIC PRIVACY AND MODESTY TACK PANELS

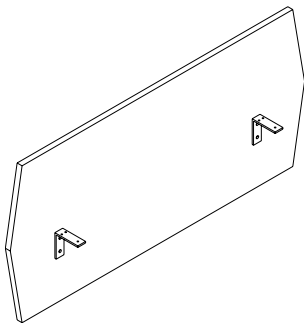

24" HIGH FABRIC PANELS

STANDARD FEATURES

- Fabric tack panels are double sided with angled sides
- Panels are mounted between desks
- Specify one for each adjustable table top
- Specify only one between two stationary desks
- Specify panel that fits work surface top size

- Tackboards are not available in COL, Leather or Vinyl materials. FABRIC ONLY

NOTES

- Gives Privacy Approximately 12" Above And 12" Below Work surface

[CLICK HERE TO VIEW PRODUCT INDEX](#)

1 SELECT A STYLE

DIMENSIONS		STYLE NUMBER	LIST PRICE	STYLE NUMBER	LIST PRICE	STYLE NUMBER	LIST PRICE
W" x D" x H"	WGT	"C" Component					
For 54" Work surfaces							
30 x .875 x 24	8	NSS3024OP718	See COM/ COL				
1 yd required							
18 Square Feet							

NSS3024OP718 Graded in Pricing

COM	COL	1	2	3	4	5	6	7	8	9	10	11/ L1	12	13/ L2
300	N/A	410	445	480	515	550	585	620	655	690	725	760	795	865

2 SELECT A FINISH 3 SELECT AN EDGE 5 OPTIONS

"C" Comp
Finishes N/A

Edge Profile
Option Not Available

No Options Available

4 SELECT HARDWARE

Hardware
Option Not Available

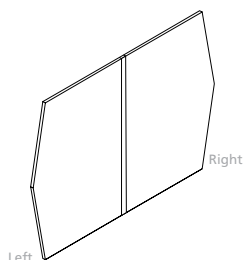

END PANEL LEFT/RIGHT

STANDARD FEATURES

- End panel attaches to end of table with end leg
- End panels used to end run of units for privacy
- Panels are mounted between desks

[CLICK HERE TO VIEW PRODUCT INDEX](#)

1 SELECT A STYLE

DIMENSIONS		STYLE NUMBER	LIST PRICE	STYLE NUMBER	LIST PRICE	STYLE NUMBER	LIST PRICE
W" x D" x H"	WGT	"C" Component					
Laminate End Panel (Left)							
32 x 1 x 48	45	NSS3248OP715	336				
Laminate End Panel (Right)							
32 x 1 x 48	45	NSS3248OP716	336				

2 SELECT A FINISH **3 SELECT AN EDGE** **5 OPTIONS**

"C" Comp			
-	-	MHC	Honey Cherry
-	-	MOC	Koko Cherry
-	-	MGW	Gunstock Walnut
-	-	MTW	Studio Teak Walnut
-	-	MWL	Designer White

Edge Profile
Option Not Available

No Options Available

4 SELECT HARDWARE

Hardware
Option Not Available

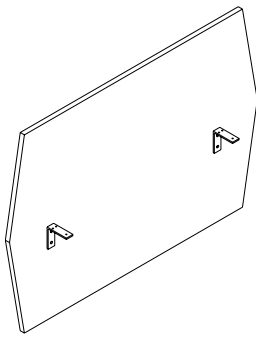

ACRYLIC PRIVACY/MODESTY PANELS

STANDARD FEATURES

- 24" High panel enables approx. 12" of privacy above the work surface and 12" of privacy below the work surface and 12" below
- 36" High panel enables approx. 18" of privacy above the work surface and 18" below
- Acrylic panels are opaque white
- Specify one for each adjustable table top
- Specify only one between two stationary desks
- Specify panel that fits top size noted

[CLICK HERE TO VIEW PRODUCT INDEX](#)

1 SELECT A STYLE

DIMENSIONS		STYLE NUMBER	LIST PRICE	STYLE NUMBER	LIST PRICE	STYLE NUMBER	LIST PRICE
W" x D" x H"	WGT	"C" Component					
For 72" Work surfaces							
48 x .5 x 36	30	NSS4836OP717	851				
For 60" or 66" Work surfaces							
41 x .5 x 36	26	NSS4136OP717	746				
For 54" Work surfaces							
30 x .5 x 36	19	NSS3036OP717	536				
For 72" Work surfaces							
48 x .5 x 24	20	NSS4824OP717	567				
For 60" or 66" Work surfaces							
41 x .5 x 24	17	NSS4124OP717	515				
For 54" Work surfaces							
30 x .5 x 24	11	NSS3024OP717	410				

2 SELECT A FINISH | **3 SELECT AN EDGE** | **5 OPTIONS**

"C"
Comp
Finishes N/A

Edge Profile
Option Not Available

No Options Available

4 SELECT HARDWARE

Hardware
Option Not Available

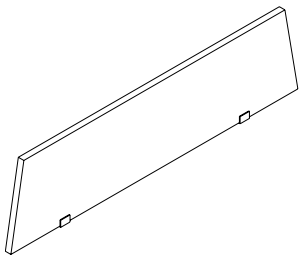

NOT SO SQUARE OPEN

ACRYLIC PRIVACY/MODESTY PANELS

HALF ACRYLIC PRIVACY PANEL

STANDARD FEATURES

- 12" High panel only provides above surface privacy
- 18" High panel only provides above surface privacy
- Acrylic panels are opaque white
- End panel attaches to end of table with end leg
- End panels used to end run of units for privacy
- Panels are mounted between desks
- Specify one for each adjustable table top
- Specify only one between two stationary desks

- Specify panel that fits top size noted

[CLICK HERE TO VIEW PRODUCT INDEX](#)

1 SELECT A STYLE

DIMENSIONS		STYLE NUMBER	LIST PRICE	STYLE NUMBER	LIST PRICE	STYLE NUMBER	LIST PRICE
W" x D" x H"	WGT	"C" Comp Component					
For 72" Work surfaces							
48 x .5 x 18	30	NSS4818OP717	467				
For 60" or 66" Work surfaces							
41 x .5 x 18	26	NSS4118OP717	420				
For 54" Work surfaces							
30 x .5 x 18	19	NSS3018OP717	326				
For 72" Work surfaces							
48 x .5 x 12	10	NSS4812OP717	362				
For 60" or 66" Work surfaces							
41 x .5 x 12	9	NSS4112OP717	320				
For 54" Work surfaces							
30 x .5 x 12	7	NSS3012OP717	236				

2 SELECT A FINISH

"C"
Comp
Finishes N/A

3 SELECT AN EDGE

Edge Profile
Option Not Available

5 OPTIONS

No Options Available

4 SELECT HARDWARE

Hardware
Option Not Available

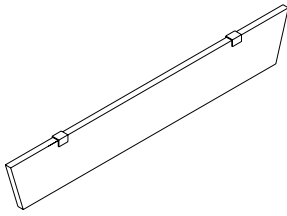

NOT SO SQUARE OPEN
ACRYLIC PRIVACY/MODESTY PANELS

OVERHEAD PRIVACY PANEL

STANDARD FEATURES

- Provides privacy on each side of the overhead

[CLICK HERE TO VIEW PRODUCT INDEX](#)

1 SELECT A STYLE

DIMENSIONS		STYLE NUMBER	LIST PRICE	STYLE NUMBER	LIST PRICE	STYLE NUMBER	LIST PRICE
W" x D" x H"	WGT	"C" Component					
<i>Mounted to Overhead</i>							
48 x .5 x 7	5	NSS4807OP717	263				

2 SELECT A FINISH

"C"
 Comp
 Finishes N/A

3 SELECT AN EDGE

Edge Profile
 Option Not Available

5 OPTIONS

No Options Available

4 SELECT HARDWARE

Hardware
 Option Not Available

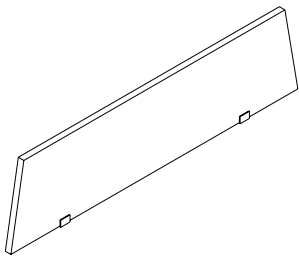

NOT SO SQUARE OPEN

ULTRACLEAR GLASS PRIVACY/MODESTY PANELS

12" HIGH GLASS PANELS

STANDARD FEATURES

[CLICK HERE TO VIEW PRODUCT INDEX](#)

1 SELECT A STYLE

DIMENSIONS		STYLE NUMBER	LIST PRICE	STYLE NUMBER	LIST PRICE	STYLE NUMBER	LIST PRICE
W" x D" x H"	WGT						
30 x 12		NSS3012OP729	1075				
36 x 12		NSS3612OP729	1200				
41 x 12		NSS4112OP729	1330				
48 x 12		NSS4812OP729	1470				

2 SELECT A FINISH

3 SELECT AN EDGE

5 OPTIONS

No Options Available

4 SELECT HARDWARE

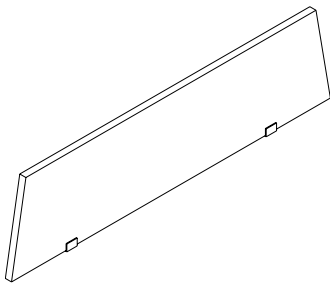

NOT SO SQUARE OPEN

ULTRACLEAR GLASS PRIVACY/MODESTY PANELS

18" HIGH GLASS PANELS

STANDARD FEATURES

[CLICK HERE TO VIEW PRODUCT INDEX](#)

1 SELECT A STYLE

DIMENSIONS		STYLE NUMBER	LIST PRICE	STYLE NUMBER	LIST PRICE	STYLE NUMBER	LIST PRICE
W" x D" x H"	WGT						
30 X 18		NSS3018OP729	1270				
36 X 18		NSS3618OP729	1515				
41 X 18		NSS4118OP729	1635				
48 X 18		NSS4818OP729	1755				

2 SELECT A FINISH

3 SELECT AN EDGE

5 OPTIONS

No Options Available

4 SELECT HARDWARE

BASE MODIFICATIONS

RUNOFF SLEIGH BASE

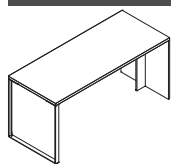

STYLE NUMBER	LIST PRICE	SPECIFICATIONS
24" Metal Sleigh Base SSB24	450	- Metal Sleigh base - standard in silver finish
30" Metal Sleigh Base SSB30	475	
36" Metal Sleigh Base SSB36	495	

Available: - Central, NOT SO square, Spaces

COMPUTER SUPPORT

DELUXE SINGLE MONITOR ARM W/ USB POST



STYLE NUMBER	LIST PRICE	SPECIFICATIONS
MA1952	495	- (4) 2.0 USB Ports - Post Length: 22-1/2"H, Post Base Requires 80mm Dia. Hole - Spring Assist - Full Movement Arm, Arm Extends Up To 13 - 3/8" - Supports Screens Up To 24", Swivels 180 degrees - Mount Plate Tilts 85 degrees - Arm: Die Cast Aluminum

Notes
- Surface Factory Bored / Ready To Install

Available: - All DARRAN Collections

COMPUTER SUPPORT

DELUXE DOUBLE MONITOR ARM W/ USB POST



STYLE NUMBER	LIST PRICE	SPECIFICATIONS
MA2952	795	- (4) 2.0 USB Ports - Post Length: 22-1/2"H, Post Base Requires 80mm Dia. Hole - Spring Assist - Full Movement Arm, Arm Extends Up To 13 - 3/8" - Supports Screens Up To 24", Swivels 180 degrees - Mount Plate Tilts 85 degrees - Arm: Die Cast Aluminum

Notes
- Surface Factory Bored / Ready To Install
- Can Accommodate Up To 4 Monitors By Ordering Extra Double Arms.
1 Extra Arm and 1 Double Clamp - Add\$305

Available: - All DARRAN Collections

COMPUTER SUPPORT

CPU RETRACTABLE CRADLE

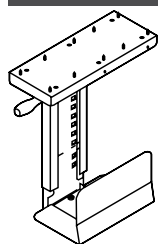

STYLE NUMBER	LIST PRICE	SPECIFICATIONS
K18	195	- Black Metal CPU Carriage - Full 360° swivel capability allows easy access to rear of CPU for cables / wires - Track allows 8- 1/2" extension - Width Adjustment 5-1/2" to 9-1/4" - Height adjustment 14- 5/8" to 20- 1/2" - Black epoxy finish

Notes
- Factory Installed

Available: - All DARRAN Collections

COMPUTER SUPPORT

ARTICULATING KEYBOARD TRAY

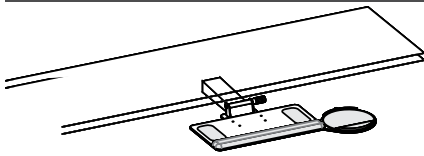

STYLE NUMBER

Factory Installed

K28

Field Installed

K28F

LIST PRICE

375

395

SPECIFICATIONS

- Adjusts effortlessly - A simple one-handed motion allows the keyboard to be repositioned instantly, without the use of locks or levers
- Encourages low-risk postures - Maximizes adjustability within a safe operating range.
- Will last a lifetime - Exceeds all applicable BIFMA Standards and comes with a lifetime guarantee.

Notes

- Factory Installed (standard)
- FIELD INSTALL - \$395

Available: - All DARRAN Collections

COMPUTER SUPPORT

TRADITIONAL PULL-OUT DRAWER WITH KEYBOARD TRAY

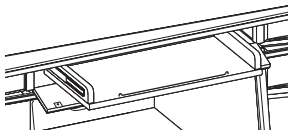

STYLE NUMBER

K21

LIST PRICE

450

SPECIFICATIONS

- Traditional Pull-out Drawer w/Keyboard Tray

Available: - Jamestown

CONFERENCE DESK SUPPORT POST OPTIONS

WOOD DRUM



STYLE NUMBER

6" Diameter Drum

B6

LIST PRICE

395

SPECIFICATIONS

- Available in Walnut / Cherry / Maple
- Adjustable levelers
- Replaces standard metal round legs

Notes

- Specify Finish

Available: - Central Park, NOT SO square

CONFERENCE DESK SUPPORT POST OPTIONS

WOOD HALF DRUM

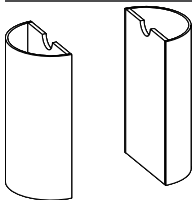

STYLE NUMBER

8" Half Drum

HC08

16" Diameter Drum

HC16

LIST PRICE

695

895

SPECIFICATIONS

- Available in Walnut / Cherry / Maple
- Adjustable levelers

Notes

- Specify Finish

Available: - Central Park, NOT SO square, Richmond Park

CONFERENCE DESK SUPPORT POST OPTIONS

METAL OVAL "T" BASE



STYLE NUMBER

Silver

32MOTS

Black

32MOTB

LIST PRICE

595

595

SPECIFICATIONS

- 3" x 1" Aluminum square extrusion
- Leveler adjustment
- Oval Post

Available: - Silver or Black

DOOR MODIFICATIONS

SOFT CLOSE DOOR HINGE



STYLE NUMBER

D9SC

LIST PRICE

15 Per Door

SPECIFICATIONS

- Snap onto standard door hinge
- Requires (1) per door
- Max door height 43"
- Factory installed where specified
- Individually shipped for field installation

Notes

- Specify Each Item To Have Slow Close Feature

Available: - All DARRAN Collections

DOOR MODIFICATIONS

DELETE DOORS

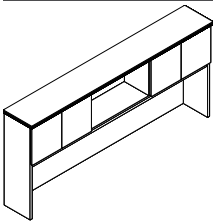

STYLE NUMBER

D6

LIST PRICE

N/C

SPECIFICATIONS

- Standard Door overheads and cabinets can have door deleted for open access. Modification of hinge rails and structural components are made face ready.

Available: - All DARRAN Collections

DOOR MODIFICATIONS

- REPLACE GLASS PANEL INSERT WITH VENEER PANEL INSERT



Glass Door

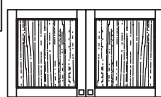

Wood Door

STYLE NUMBER

D35

LIST PRICE

30 per door

SPECIFICATIONS

- Replace glass panel insert with veneer panel insert

Notes

- Not Available on "M" skus
- Glass door has beveled glass
- Wood door w/ veneer insert - only available on "W" style

Available: - Capitol Park, Jamestown, Prado, Richmond Park

DOOR MODIFICATIONS

DELETE DOORS/REPLACE BLACK LAMINATE SHELF W/ FINISHED SHELF

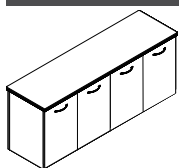

STYLE NUMBER
D6A

LIST PRICE
N/C

SPECIFICATIONS
- Delete doors and replace black laminate shelf with finished shelf

Available: - All Storage Credenzas ("W"/"G" Styles).
Excludes Rail.

DOOR MODIFICATIONS

PANEL DOOR LOCK

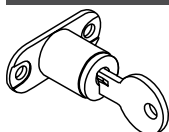

STYLE NUMBER
D2

LIST PRICE
95 Per Door Set

SPECIFICATIONS
- Door Locks - 1 Door w/ Lock, Other Door w/ Catch Latch
- Contact Customer Service regarding limited lock locations and keying.

Available: - Panel Doors, Wood Frame Doors, and Silverluma doors

DOOR MODIFICATIONS

GLASS DOOR LOCK

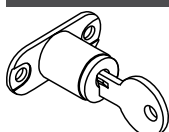

STYLE NUMBER
D2-G

LIST PRICE
195 Per Door Set

SPECIFICATIONS
- Door Locks - 1 Door w/ Lock, Other Door w/ Catch Latch
- Contact Customer Service regarding limited lock locations and keying.

Available: - Glass Doors

DOOR MODIFICATIONS

BOX DRAWER ACCESSORIES

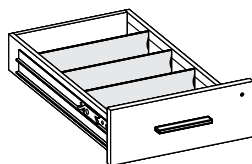

STYLE NUMBER
Wood Drawer Dividers w/ Clips
K-DIV
Single Tray - Utility Tray
K-Sut

LIST PRICE
SET OF 3 - 30
30 each

SPECIFICATIONS
- K-DIV Extra Wood Drawer Dividers with Clips, Top Box drawers standard with 1 divider
- K-SUT Single Tray - Utility Tray, Specify Legal or Letter drawer width

Available: - All DARRAN Collections. Excludes Rail.

DRAWER OPTIONS

TRADITIONAL CENTER DRAWER

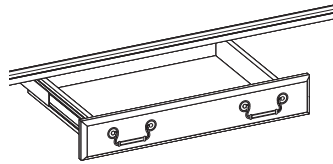

STYLE NUMBER
K17
Add Skirt Option
K17-SK

LIST PRICE
225

325

SPECIFICATIONS
- Standard on desks in Jamestown Collection. Optional center drawers available for bullet conference desk, kneespace credenzas and corner units. 3 ply hardwood drawer / dowel construction profile shaped drawer front. Specify pull choice.

Available: - Jamestown

DRAWER OPTIONS

FINISHED TRADITIONAL CENTER DRAWER

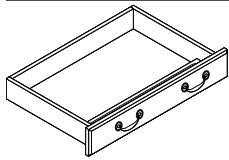

STYLE NUMBER
K30
Add Skirt Option
K30-SK

LIST PRICE
195

295

SPECIFICATIONS
- Veneer drawer front finished to match unit veneer. Edges are scalloped to match standard drawers.
- Standard with matching wood grain pencil tray
- Pulls selected to match unit installed

Available: - Richmond Park

DRAWER OPTIONS

FINISHED CENTER DRAWER

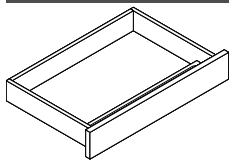

STYLE NUMBER
K31
Add Skirt Option
K31-SK

LIST PRICE
195

295

SPECIFICATIONS
- Veneer drawer front finished to match unit W or G style veneer.
- Ball bearing smooth operation
- Drawer has lifetime guarantee
- Standard with matching wood grain pencil tray
- Laminate drawer front to match laminate unit (M style)

Available: - Central Park, NOT SO square, Rail

DRAWER OPTIONS

PRADO/SPACES CENTER DRAWER - VENEER BOTTOM

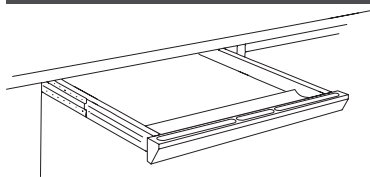

STYLE NUMBER
Factory Installed
K1
Field Installed
K1BVF

LIST PRICE
275

275

SPECIFICATIONS
- Solid hardwood front beveled and rounded with recessed pencil tray.

Available: - Prado, Spaces

DRAWER OPTIONS

CENTER DRAWER

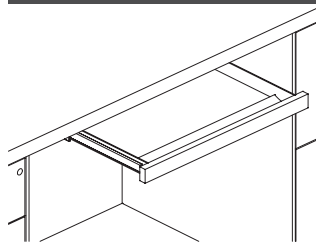

STYLE NUMBER

LIST PRICE

SPECIFICATIONS

Factory Installed

- Center Drawer - Factory Installed, Center Drawer - Field Installed

K1R

275

Field Installed

K1RF

275

Available: - Rift

DRAWER OPTIONS

CENTER DRAWER WITH SKIRT

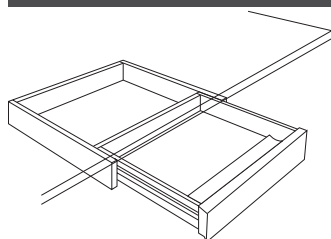

STYLE NUMBER

LIST PRICE

SPECIFICATIONS

Factory Installed

- Center Drawer - Factory Installed, Center Drawer - Field Installed

K2R

375

Field Installed

K2RF

375

Add Skirt Option

K2R-SK

475

Available: - Rift

DRAWER OPTIONS - BOTTOM COVER

BLACK DURA-LEATHER DRAWER BOTTOM COVERS

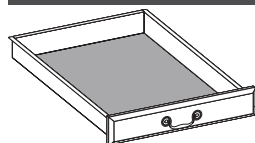

STYLE NUMBER

LIST PRICE

SPECIFICATIONS

P2

75

- Center drawer and Box/Tray drawers are covered in Black Duraleather that adds a prestigious touch.

Available: - Jamestown

DRAWER OPTIONS - BOTTOM COVER

FELT BOTTOM CENTER DRAWER INSERT LINER



STYLE NUMBER

LIST PRICE

SPECIFICATIONS

K3

95

- Inserts into center drawer and features divider for open pen and pencil storage. Removable for easy cleaning.
 - Adds a luxurious touch to center drawers.
 - Color: Dark Brown Coal

Available: - All DARRAN Collections. Excludes Rail.

DRAWER OPTIONS - UPGRADE

WOOD DRAWER UPGRADE

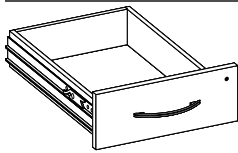

STYLE NUMBER
P33

LIST PRICE
40 Per Drawer

SPECIFICATIONS

- Dowel joint construction
- Hardwood veneer multi-ply drawer
- UV finish
- 1/4" Wood veneer bottoms
- File drawer bottoms are fiv block reinforced for heavy weight capacity
- Lifetime guaranteed

Available: - Central Park, Capitol Park, NOT SO square, Rail, Richmond Park

LIGHTING

LT-LED TASK LIGHT

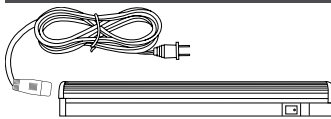

STYLE NUMBER
24" Tasklight
LT-LED24
48" Tasklight
LT-LED48
60" Tasklight
LT-LED60
Linking Cable
LC22

LIST PRICE
90
165
180
20

SPECIFICATIONS

- Anodized aluminum finish
- Tilting beam allows adjustability
- Switch with dimming control
- 50,000 hour life
- 12V power drive standard with each task light 30 watt max

Notes
- LC22: 20" LT-LED Task light linking cable

Available: - All DARRAN Collections

LIGHTING

DELETE TASK LIGHT CONCEALMENT APRON RAIL

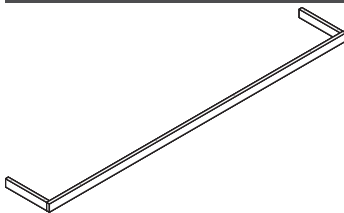

STYLE NUMBER
WAR-D

LIST PRICE
Deduct 125

SPECIFICATIONS
- Delete Tasklight Concealment apron rail when a task light is not used on a wall hung unit

Available: - Wall Hung Units

LIGHTING

SLIM LINE ALUMINUM LED TASK LIGHT

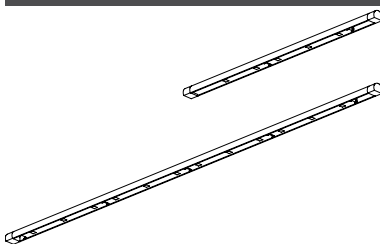

STYLE NUMBER
24" Tasklight
LED24
48" Tasklight
LED48
60" Tasklight
LED60
Linking Package
DPC

LIST PRICE
315
445
555
Deduct 85 per task light

SPECIFICATIONS

- Anodized aluminum finish
- Tilting beam allows adjustability
- Switch with dimming control
- 50,000 hour life
- 12V power drive standard with each task light 30 watt max

Notes
- Link multiple tasklights up to 30W of power wattage. Deletes 1 power drive

Available: - Rift and Spaces

LIGHTING

LED INTERIOR CABINET PUCK LIGHT

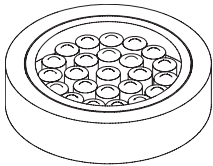

STYLE NUMBER

LIST PRICE

SPECIFICATIONS

Starter Kit

295

- Starter kit includes Infeed, 1 Puck Interior Light and the ability to daisy chain up to 6 total Puck Lights
- (1) LED Puck Light with 30W power drive and switch

LEDPK

1 LED Interior Puck Light

125

- Recessed fixture
- 12V linking cord 98"L
- Silver finish
- 50,000 hour life
- 2 watt per light

Notes

- Power drive included, Light only

Available: - Overhead/Tower Units with glass doors or no doors

PEDESTAL MODIFICATIONS

BREAKFRONT PEDESTAL WITH WIRE MANAGEMENT CAVITY DOOR

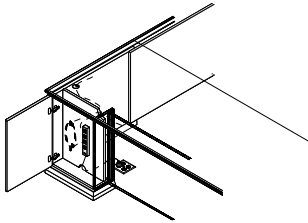

STYLE NUMBER

LIST PRICE

SPECIFICATIONS

PC10

95

- Hinged pedestal front door offers easy access for wire management

Power Supply Cordset

PD717

95

- Wire hooks provide wire coil storage
- Wire access openings allow access to floor, cabinets interior and kneespace
- Cabinet interior is black finish
- Top grommet is positioned over cavity for access ease
- (Power Strip Optional)

Notes

- Breakfront Chassis Only

Available: - All DARRAN Collections. Excludes Jamestown, Rail, Richmond, and Rift.

PEDESTAL MODIFICATIONS

BLACK LAMINATE PRINTER PULLOUT BOTTOM SHELF

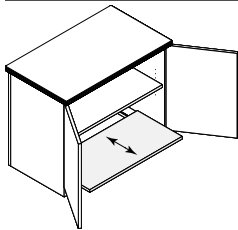

STYLE NUMBER

LIST PRICE

SPECIFICATIONS

PPOS

214

- Black Laminate pullout shelf on suspension
- Black grommet
- Adjustable Shelf

Available: - All DARRAN Collections. Excludes Rail.

PEDESTAL MODIFICATIONS

ADD VENEER KNEESPACE CABINETS - BASE

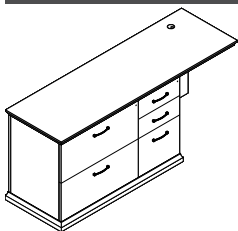

STYLE NUMBER

LIST PRICE

SPECIFICATIONS

Add Box/Box/File or File/File

985

- Multi-file specify Box/Box Left or Right

P40B

Add Lateral File 29" W

P41B

1205

Notes

- Add additional Standard Cabinets To Kneespace Area.

Add Multi-File - 31"W

P42B

1205

Add Storage With Doors 29"W

P43B

1095

Add CPU /Printer Cabinet - Open

P44B

1095

Available: - Capitol Park, Jamestown, Prado, Richmond Park

PEDESTAL MODIFICATIONS

ADD VENEER KNEESPACE CABINETS - NO BASE

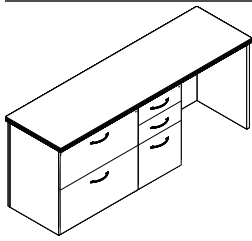

Available: - Central Park, NOT SO square

STYLE NUMBER	LIST PRICE
Add Box/Box/File or File/File P40W	875
Add Lateral File 29" W P41W	985
Add Multi-File - 31"W P42W	1095
Add Storage With Doors 29"W P43W	985
Add CPU /Printer Cabinet - Open P44W	985

SPECIFICATIONS
- Multi-file specify Box/Box Left or Right

Notes
- Add additional Standard Cabinets To Kneespace Area.

PEDESTAL MODIFICATIONS

ADD TECH VENEER KNEESPACE CABINETS - NO BASE

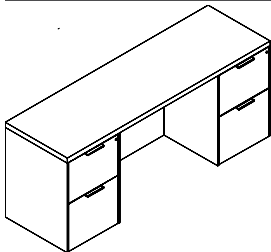

Available: - Rift

STYLE NUMBER	LIST PRICE
Add Box/Box/File or File/File P40T	1100
Add Lateral File 29" W P41T	1210
Add Multi-File - 31"W P42T	1320
Add Storage With Doors 29"W P43T	1210
Add CPU /Printer Cabinet - Open P44T	1210

SPECIFICATIONS
- Multi-file specify Box/Box Left or Right

Notes
- Add additional Standard Cabinets To Kneespace Area.

PEDESTAL MODIFICATIONS

ADD MELAMINE (TFL) KNEESPACE CABINETS - NO BASE

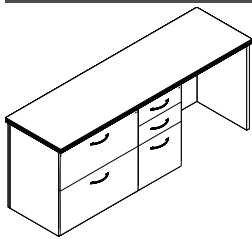

Available: - Central Park (TFL) and NOT SO square (TFL)

STYLE NUMBER	LIST PRICE
Add Box/Box/File or File/File P40M	688
Add Lateral File 29" W P41M	853
Add Multi-File - 31"W P42M	963
Add Storage With Doors 29"W P43M	765
Add CPU /Printer Cabinet - Open P44M	875

SPECIFICATIONS
- Multi-file specify Box/Box Left or Right

Notes
- Add additional Standard Cabinets To Kneespace Area.

PEDESTAL MODIFICATIONS

MODIFY DRAWER CONFIGURATIONS

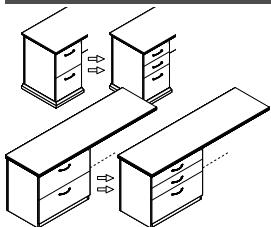

Available: - All DARRAN Collections. Excludes Rail.

STYLE NUMBER	LIST PRICE
File/File to Box/Box/File P6	50 per pedestal
Box/Box/File to File/File P6	50 per pedestal
Lateral File to 2 Box Drawers P8	95 per pedestal

SPECIFICATIONS
- Modify File/File To Box/Box/File - Any Unit

PEDESTAL MODIFICATIONS

MODIFY DRAWER CONFIGURATIONS

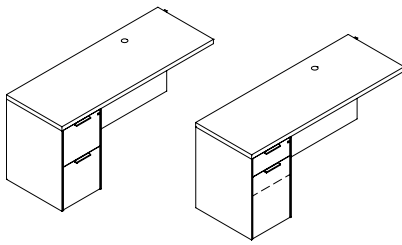

STYLE NUMBER

File/File to Box/Box/File

P6H

Lateral File to 2 Box Drawers

P8

LIST PRICE

95 per pedestal

95 per pedestal

SPECIFICATIONS

- Modify File/File To Box/Hidden Box/File - Any Unit

Available: - Rift

POWER / DATA

POWER SUPPLY CORDSET

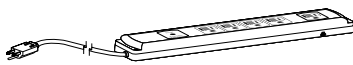

STYLE NUMBER

PD717

LIST PRICE

95

SPECIFICATIONS

- SIZE: 10.75"L x 2.0"W x 1.06"H

- (5) Outlets w/ 10' cord

- Surge suppression (720 Joules)

- 15 Amp breaker

- Available on: Vertical Panels, Cabinet Interiors, and under tops

Available: - All DARRAN Collections

PRODUCT MODIFICATIONS

MODIFY WIDTH - OPEN KNEESPACE

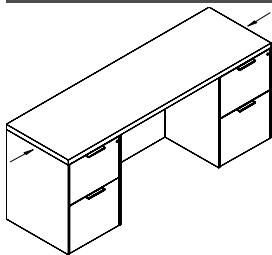

STYLE NUMBER

MOD-1

LIST PRICE

125

SPECIFICATIONS

- Modify width down on any unit with an open kneespace: desk, workstation credenza, bridge, return

Available: - All DARRAN Collections

PRODUCT MODIFICATIONS

MODIFY WIDTH - OPEN/CLOSED STORAGE

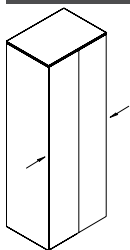

STYLE NUMBER

MOD-2

LIST PRICE

250

SPECIFICATIONS

- Modify width down on any unit with open or closed storage section: overheads, wall hung units, storage credenzas, towers

Available: - All DARRAN Collections

PRODUCT MODIFICATIONS

MODIFY WIDTH - OUTSIDE OF MOD-1, MOD-2

STYLE NUMBER
MOD-3

LIST PRICE
Contact Factory
for Pricing

SPECIFICATIONS
- Width modification outside of MOD-1 & MOD-2

Available: - All DARRAN Collections

PRODUCT MODIFICATIONS

MODIFY WIDTH - TACKBOARD, SLAT WALL, VENEER PANEL, OR A GLASSBOARD

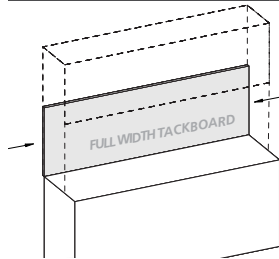

STYLE NUMBER
MOD-4

LIST PRICE
50

SPECIFICATIONS
- Modify width down on tackboard, slat wall, veneer panel, or a overhead glassboard

Available: - All DARRAN Collections

PRODUCT MODIFICATIONS

MODIFY DEPTH - DECREASE DEPTH

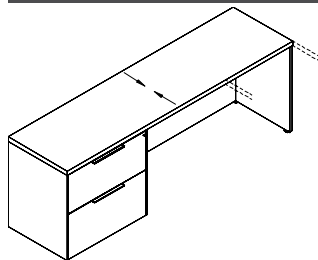

STYLE NUMBER
MOD-5

LIST PRICE
125

SPECIFICATIONS
- Modify depth down (minimum depth for a unit with drawers is 21"D)

Notes
- Ex. 24" to 21", 30" to 24", and 36" to 30"

Available: - All DARRAN Collections

PRODUCT MODIFICATIONS

MODIFY DEPTH - INCREASE DEPTH

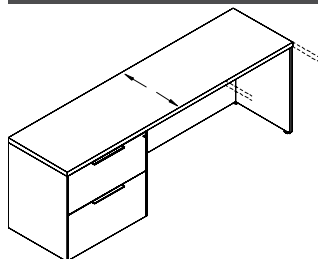

STYLE NUMBER
MOD-6

LIST PRICE
Add 10%

SPECIFICATIONS
- Increase depth
Notes
- Ex. 24" to 30", 30" to 36", and 36" to 42"

Available: - All DARRAN Collections. Excludes Rift.

PRODUCT MODIFICATIONS

MODIFY HEIGHT

STYLE NUMBER	LIST PRICE	SPECIFICATIONS
MOD-7	Contact Factory for Pricing	- Modify height of a unit

Available: - All DARRAN Collections

PRODUCT MODIFICATIONS

MODIFY CONFERENCE TABLE LENGTH AND WIDTH - 1 PIECE TOP

STYLE NUMBER	LIST PRICE	SPECIFICATIONS
MOD-8	125	- Modify length/width down on a 1 piece table top

Available: - Conferencing

PRODUCT MODIFICATIONS

MODIFY CONFERENCE TABLE LENGTH AND WIDTH - 2/3 PIECE TOP

STYLE NUMBER	LIST PRICE	SPECIFICATIONS
MOD-9	250	- Modify length/width down on a 2 or 3 piece table top

Available: - Conferencing

REFRIGERATOR MODIFICATION

REFRIGERATOR CABINET MODIFICATION

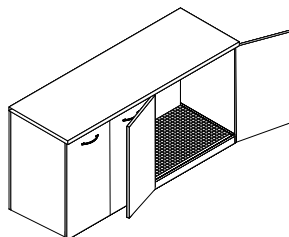

STYLE NUMBER	LIST PRICE	SPECIFICATIONS
REF01	195	- Open back cutout for venting - Moisture sponge mat - Contaminate ledge - Contact customer service for maximum refrigerator size (Changes based on unit).

Available: - Storage Credenzas

SHAPED TOPS **OVERHEAD/WALL HUNG SHAPED TOP**

STYLE NUMBER	LIST PRICE	SPECIFICATIONS
99"W - 105"W		- Shaped tops for overheads and wall hungs
TOH-1	405	
58"W - 93"W		
TOH-2	315	
29"W - 47"W		
TOH-3	203	

Available: - Central Park, Rail

SHAPED TOPS **BOOKCASE SHAPED TOP**

STYLE NUMBER	LIST PRICE	SPECIFICATIONS
29"W - 35"W x 15"D		- 15" D Shaped tops for bookcases
TOH-4	203	- Shaped on front

Available: - Central Park, Rail

SHAPED TOPS **TOWER SHAPED TOP**

STYLE NUMBER	LIST PRICE	SPECIFICATIONS
16" Single Width Tower		- 24" deep shaped tops for towers
TOH-5	158	- Shaped on front
29"W - 46"W Tower		
TOH-6	203	

Available: - Central Park, Rail

SHAPED TOPS **WORKSURFACE SHAPED TOP**

STYLE NUMBER	LIST PRICE	SPECIFICATIONS
Shape Four Sides		- S4S Applies to desk, bridge or any freestanding unit. This adds shapes or copes to two sides (desk, bridges) or one side and back of units (returns).
S4S	50	
Shape Three Sides		- S3S Applies to credenza units. This adds shapes to the two sides.
S3S	50	- Credenzas are shaped front standard with flat back
		Notes
		- Desk, Freestanding and Credenza units will grow 1" in width due to adding shapes on ends of units.

Available: - Central Park

SHAPED TOPS

PREMIUM EDGE - SHAPED WORKSURFACE TOP

STYLE NUMBER	LIST PRICE	SPECIFICATIONS
<i>Shape Four Sides Premium Edge</i>		
S4S-PE	Add 10%	- S4S-PE Applies to desk, bridge or any freestanding unit. This adds shapes or copes to two sides (desk, bridges) or one side and back with hardwood rims (returns).
<i>Shape Three Sides Premium Edge</i>		
S3S-PE	Add 10%	- S3S-PE Shape Three Sides Premium Edge. Applies to credenza units. This adds shape to the two sides with hardwood rims.
* 10% Upcharge includes 5% for premium edge		<p>Notes</p> <ul style="list-style-type: none"> - Desk, Freestanding and Credenza units will grow 1" in width due to adding shapes on ends of units.

Available: - Central Park

SHELF MODIFICATIONS

GLASS SHELVES - TEMPERED FULL WIDTH 26" - 35"

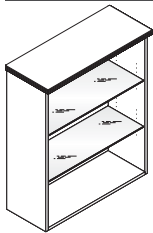

STYLE NUMBER	LIST PRICE	SPECIFICATIONS
<i>26"W - 35"W x 14"D Shelf</i>		
GS14F	85	- Glass Shelves Replace Wood Shelf In Open Or Glass Door Cabinet. Also Order Interior Cabinet Lighting.

Available: - All DARRAN Collections

SHELF MODIFICATIONS

TEMPERED GLASS SHELVES FOR HALF CABINET 17- 1/2" WIDTHS

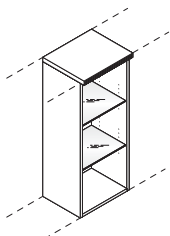

STYLE NUMBER	LIST PRICE	SPECIFICATIONS
<i>14-1/2"W - 17- 1/2"W x 14"D Shelf</i>		
GS14H	65 ea	- Glass Shelves Replace Wood Shelf In Open Or Glass Door Cabinet. Also Order Interior Cabinet Lighting.

Notes

- Replace only adjustable shelves between cabinet light and fixed lower wood shelf.

Available: - All DARRAN Collections

SHELF MODIFICATIONS

CURVED CORNER GLASS SHELF

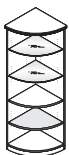

STYLE NUMBER	LIST PRICE	SPECIFICATIONS
GS14CC	85 ea	- Curved shelves feature glass retainer clips to prevent tipping

Notes

- Replace only adjustable shelves between cabinet light and fixed lower wood shelf.

Available: - All DARRAN Collections. Excludes Rail.

SHELF MODIFICATIONS

HEAVY DUTY SOLID WOOD BOOKCASE REPLACEMENT SHELVES

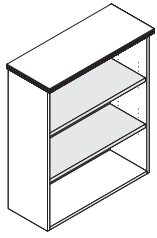

STYLE NUMBER
1" Wood Shelf 14" Deep
 S714F
1" Wood Shelf 24" Deep
 S714FX

LIST PRICE
 75 ea
 150 each

SPECIFICATIONS
 - 1" Solid Lumber Core Shelves Replace Standard 3/4" Plywood
 Adjustable And Fixed Shelves

Available: - All DARRAN Collections. Excludes Rail.

SLAT WALL ACCESSORIES

SLAT WALL ACCESSORY TRAY

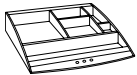

STYLE NUMBER
 SWA9

LIST PRICE
 45

SPECIFICATIONS
 - Specify Black Or Matte Silver

Available: - All DARRAN Collections. Excludes Rail.

SLAT WALL ACCESSORIES

SLAT WALL FOLDER TRAY



STYLE NUMBER
 SWA7

LIST PRICE
 45

SPECIFICATIONS
 - Specify Black Or Matte Silver

Available: - All DARRAN Collections. Excludes Rail.

SLAT WALL ACCESSORIES

SLAT WALL PAPER TRAY

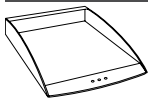

STYLE NUMBER
 SWA2

LIST PRICE
 35

SPECIFICATIONS
 - Specify Black Or Matte Silver

Available: - All DARRAN Collections. Excludes Rail.

SLAT WALL ACCESSORIES

SLAT WALL PENCIL HOLDER



STYLE NUMBER
SWA4

LIST PRICE
25

SPECIFICATIONS
- Specify Black Or Matte Silver

Available: - All DARRAN Collections. Excludes Rail.

SPECIALTY VENEER ACCENTS

BLACK EBONY WOOD INLAY IN ONE PIECE CONFERENCE TOP

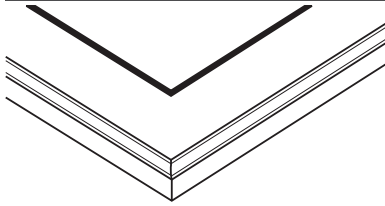

STYLE NUMBER
One Piece Conference Top
T30
Two Piece Conference Top
T31

LIST PRICE
735
1480

SPECIFICATIONS
- Standard veneer top is routed for Ebony wood inlay 1/8" x 3/16" width line. Inlay wood is miter jointed in the corners, hand fitted, glued and sanded flush with top veneer. Inlay forms a 3" border to top edge

Notes
- Hand fitted miter corner Black Ebony wood inlay installed in standard wood veneer tops

Available: - Conferencing Tops.

SPECIALTY VENEER ACCENTS

BLACK/WHITE/BLACK WOOD INLAY

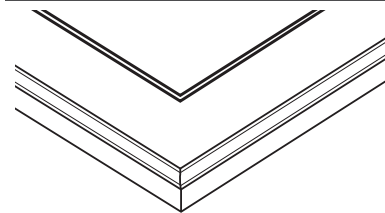

STYLE NUMBER
One Piece Top
T30BWB
Two Piece Top
T31BWB

LIST PRICE
950
1795

SPECIFICATIONS
- Standard veneer top is routed for wood inlay 1/8" x 3/16" width line. Each color is 1/16" wide. White inlay line is finished over providing a subtle contrast to line detail

Notes
- Hand fitted miter corner ebony-maple-ebony wood inlay installed in standard veneer top
- The center white line can be masked off preventing color stains from penetrating. Final top coats are applied over the white line.

Available: - Conferencing Tops

SPECIALTY VENEER ACCENTS

BLACK EBONY WOOD INLAY W/ WOOD FAN DETAIL - 1 PIECE CONFERENCE TABLE TOP

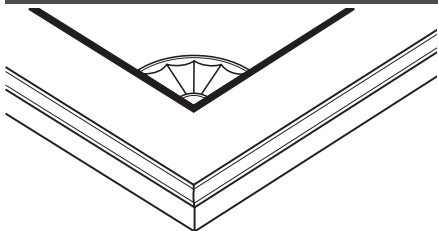

STYLE NUMBER
One Piece Top
T51
Two Piece Top
T52

LIST PRICE
1160
2110

SPECIFICATIONS
- Standard veneer top is routed for wood inlay 1/8" x 3/16" width line. With each 90 degree corner routed for Quarter circle fan inlays. Inlay fans combined with solid black inlay preserves an old traditional appearance. Fans are handcrafted from teakwood, rosewood, mahogany, and other exotic woods. Each piece of veneer is shaded by burning and is hand fitted to a perfect fan shape - truly and old world craft
- Conference tables: 4 fans, one in each corner per top section

Notes
- Hand fitted miter corner wood inlay and fan installed in standard veneer top
- Only available on square/ rectangle tops

Available: - Conferencing Tops

SPECIALTY VENEER ACCENTS

CROTCH MAHOGANY INFIELD WITH MITERED BORDER



STYLE NUMBER

- TCB-1 - 84 x 36/42
- TCB-2 - 72 x 36/42
- TCB-3 - 72 x 30/36

LIST PRICE

- 1895
- 1795
- 1695

SPECIFICATIONS

- Center balanced butt and book matched crotch mahogany
- 35 sheen non-rubbed finish ensures maximum durability

Available: - Jamestown, Prado

SPECIALTY VENEER ACCENTS

CROTCH MAHOGANY DESK PEDESTAL FRONTS

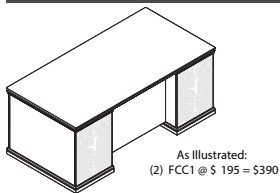

Desk Approach
Pedestal Fronts

STYLE NUMBER

FCC1

LIST PRICE

195 per pedestal

SPECIFICATIONS

- Center balanced butt and book matched crotch mahogany
- 35 sheen non-rubbed finish ensures maximum durability

Available: - Jamestown, Prado

SPECIALTY VENEER ACCENTS

CROTCH MAHOGANY DRAWER FRONTS

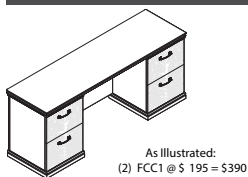

Box/Box/File or File/File
Drawer Fronts

STYLE NUMBER

FCC1

LIST PRICE

195 per pedestal

SPECIFICATIONS

- Center balanced butt and book matched crotch mahogany
- 35 sheen non-rubbed finish ensures maximum durability

Available: - Jamestown, Prado

SPECIALTY VENEER ACCENTS

CROTCH MAHOGANY DOUBLE WIDTH PANEL FRONTS



All Three Illustrations Represent: (1) FCC2 @ \$395

30-32-36 Width
FCC-2 \$395 per Panel Set

STYLE NUMBER

FCC2

LIST PRICE

395 per Panel Set

SPECIFICATIONS

- Center balanced butt and book matched crotch mahogany
- 35 sheen non-rubbed finish ensures maximum durability

Available: - Jamestown, Prado

SPECIALTY VENEER ACCENTS

CROTCH MAHOGANY DOUBLE WIDTH/ DOUBLE HEIGHT FRONTS



STYLE NUMBER
FCC3

LIST PRICE
895 per Panel Set

SPECIFICATIONS
- Center balanced butt and book matched crotch mahogany
- 35 sheen non-rubbed finish ensures maximum durability

Both Illustrations Represent:
(1) FCC3 @ \$895 - Panel Set
30-36 Width
FCC-3 \$895 per Panel Set
52" Center Balance Butt & Bookmatch

Available: - Jamestown, Prado

SPECIALTY VENEER ACCENTS

RECTANGLE INLAY - RECESSES DURA-LEATHER WRITING SURFACE

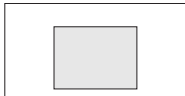

RECTANGLE INLAY

STYLE NUMBER
RL-29A

LIST PRICE
895

SPECIFICATIONS
- Recessed inlay desk pads are covered with Alomost Leather from Paul Brayton Designs.
- DARRAN will gladly custom quote other inlay materials ie: solid surfaces, biocomposites, metallic laminates, or genuine leather to match seating

Available: - All DARRAN Collections

SPECIALTY VENEER ACCENTS

BOWFRONT INLAY - RECESSES DURA-LEATHER WRITING SURFACE

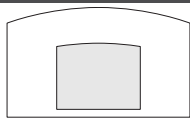

BOWFRONT INLAY

STYLE NUMBER
RL-31A

LIST PRICE
995

SPECIFICATIONS
- Recessed inlay desk pads are covered with Alomost Leather from Paul Brayton Designs.
- DARRAN will gladly custom quote other inlay materials ie: solid surfaces, biocomposites, metallic laminates, or genuine leather to match seating

Available: - All DARRAN Collections

SPECIALTY VENEER ACCENTS

RECTANGLE INLAY - EBONY HARDWOOD INLAY DETAIL

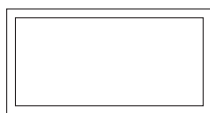

RECTANGLE INLAY

STYLE NUMBER
T10SA

LIST PRICE
895

SPECIFICATIONS
- 3/16" x 3/16" thick hardwood ebony inlay is handfitted and glued into routed top and sanded flush with surface
- Inlay is finished over with all finish steps

Notes
- Ebony inlay not recommended in: Koko Cherry

Available: - All DARRAN Collections

SPECIALTY VENEER ACCENTS

BOWFRONT INLAY - EBONY HARDWOOD INLAY DETAIL

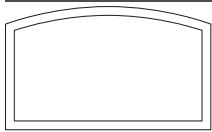

CURVED INLAY

STYLE NUMBER
T11SA

LIST PRICE
995

SPECIFICATIONS
- 3/16" x 3/16" thick hardwood ebony inlay is handfitted and glued into routed top and sanded flush with surface
- Inlay is finished over with all finish steps

Notes
- Ebony inlay not recommended in: Koko Cherry

Available: - All DARRAN Collections

TOOL CHANNEL ACCESSORIES

RECESSED ALUMINUM TOOL CHANNEL

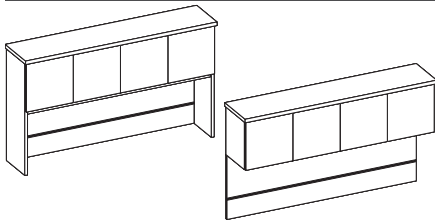

STYLE NUMBER
ATB02

LIST PRICE
5 per 1"W

SPECIFICATIONS
- Anodized aluminum finish
- Fully recessed
- Finish matches anodized aluminum accessories
- Can be specified with fabric tack surface mounted above channel

Notes
- If using tool channel with wallhung overhead, a veneer panel must be specified.

Available: - All DARRAN Collections. Excludes Rail.

TOOL CHANNEL ACCESSORIES

FILE HOLDER

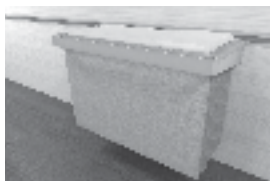

STYLE NUMBER
ATB37

LIST PRICE
105

SPECIFICATIONS
- For Console/Wall Hung Back Panels With Optional Tool Bar
- 18 Gauge Steel - Stamp Formed
- Silver Powderdercoat Finish

Available: - All DARRAN Collections. Excludes Rail.

TOOL CHANNEL ACCESSORIES

IPHONE HOLDER



STYLE NUMBER
ATB31

LIST PRICE
120

SPECIFICATIONS
- For Console/Wall Hung Back Panels With Optional Tool Bar
- 18 Gauge Steel - Stamp Formed
- Silver Powderdercoat Finish
- 5" x 3 -3/4"W
- Non-slip Neoprene pad

Available: - All DARRAN Collections. Excludes Rail.

TOOL CHANNEL ACCESSORIES

LARGE SHELF

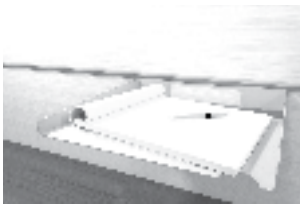

STYLE NUMBER
ATB35

LIST PRICE
125

SPECIFICATIONS
- 12"W x 10"D

Available: - All DARRAN Collections. Excludes Rail.

TOOL CHANNEL ACCESSORIES

PENCIL PEN HOLDER



STYLE NUMBER
ATB38

LIST PRICE
115

SPECIFICATIONS
- For Console/Wall Hung Back Panels With Optional Tool Bar
- 18 Gauge Steel - Stamp Formed
- Silver Powderdercoat Finish
- 5"H x 4"W x 4"D

Available: - All DARRAN Collections. Excludes Rail.

TOOL CHANNEL ACCESSORIES

SMALL SHELF



STYLE NUMBER
ATB36

LIST PRICE
110

SPECIFICATIONS
- 12"W x 6 -3/4"D

Available: - All DARRAN Collections. Excludes Rail.

TOOL CHANNEL ACCESSORIES

TABLET HOLDER

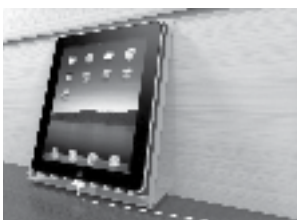

STYLE NUMBER
ATB30

LIST PRICE
135

SPECIFICATIONS
- For Console/Wall Hung Back Panels With Optional Tool Bar
- 18 Gauge Steel - Stamp Formed
- Silver Powderdercoat Finish
- 10" x 8"W
- Non-slip Neoprene pad

Available: - All DARRAN Collections. Excludes Rail.

TOP MODIFICATION

1/4" RECTANGLE SOFT ETCH GLASS RUNOFF WORKSURFACE

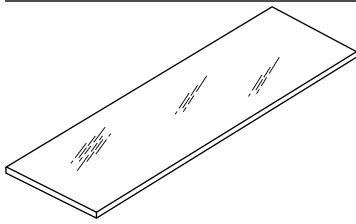

STYLE NUMBER

SEGW8436
 SEGW8430
 SEGW7836
 SEGW7830
 SEGW7230
 SEGW6630
 SEGW6030

LIST PRICE

2210
 1870
 2070
 1750
 1630
 1515
 1395

SPECIFICATIONS

- 1/4" Soft etch glass
 - Back painted white glass

Notes

- Additional colors can be custom quoted. Contact factory for pricing.

Available: - Rift Runoff Worksurface

TOP MODIFICATION

TOP APRON RAIL

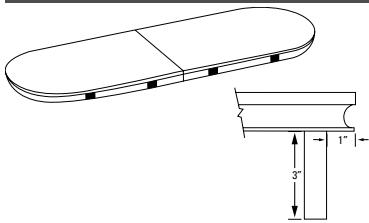

STYLE NUMBER

TAR

LIST PRICE

Add 10% to top price for apron only

SPECIFICATIONS

- 3 x 3/4 thick apron rail is set back under top 1".
 - Apron rail is recommended for fixed port installation for power/data support.

Notes

- Select power/data support separately.
 - See power options for available apron power: UDT2/VD-SM

Available: - Conferencing Tops Only

TOP MODIFICATION

TOP APRON RAIL



STYLE NUMBER

TAR-M

LIST PRICE

Add 15% (Apron rail with beltline detail)

SPECIFICATIONS

- Traditional with apron rail and molding - available in Cherry and Walnut.

Notes

- Select power/data support separately.
 - See power options for available apron power: UDT2/VD-SM

Available: - Conference tops only

WIRE MANAGEMENT

HORIZONTAL J-CHANNEL WIRE MANAGEMENT RACEWAY

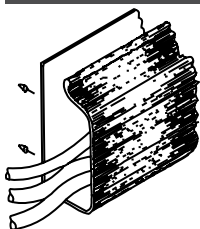

STYLE NUMBER

W1

LIST PRICE

75 Per 4 Foot Section

SPECIFICATIONS

- 4' section for field installation.
 - The "J" shape black thermoplastic wire raceway may be added to specified worksurface tops to provide concealed channeling of wires to and from worksurface grommets. For use in open kneespace areas, raceway is attachable to top of back panel with pan head screws. Interior dimensions are 1" x 1- 1/2" providing ample storage for multiple wires and excess cable. Front of raceway flexes out for easy cord insertion.

Notes

- Units w/ Wire Channel Standard.
 - Field Installation

Available: - All DARRAN Collections.

WIRE MANAGEMENT

HORIZONTAL U-CHANNEL WIRE MANAGEMENT RACEWAY



STYLE NUMBER
W2A

LIST PRICE
75 Per 4 Foot Section

SPECIFICATIONS
- 4' section for field installation.

Notes
- Units w/ Wire Channel Standard.
- Field Installation

Available: - All DARRAN Collections.

WIRE MANAGEMENT

COIL WIRE MANAGER



STYLE NUMBER
W18

LIST PRICE
150

SPECIFICATIONS
- Weighted Base, Table attachment plate
- 39- 1/2" Length
- Black

Notes
- Location

Available: - All DARRAN Collections.

WIRE MANAGEMENT

STANDARD LOCATION GROMMETS - FACTORY INSTALLED

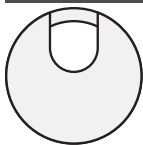

STYLE NUMBER
Standard Location Grommet

Black
TM30

Silver
TM31

Antique Brass
TM33

White
TM34

LIST PRICE

45

45

45

45

45

SPECIFICATIONS
- 1 -5/8" Metal Grommet

Notes
- *Units w/ Grommets Standard Are Noted Under Standard Features. Grommets Match Pull Finish - Standard (Unless Specified Otherwise)

Available: - All DARRAN Collections.

WIRE MANAGEMENT

NON-STANDARD LOCATION GROMMETS - FACTORY INSTALLED

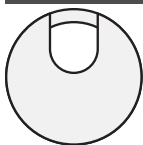

STYLE NUMBER
Non-Standard Location Grommet

Black
TM30 -NS

Silver
TM31 -NS

Antique Brass
TM33 -NS

White
TM34 -NS

LIST PRICE

90

90

90

90

90

SPECIFICATIONS
- 1 -5/8" Metal Grommet

Notes
- *Units w/ Grommets Standard Are Noted Under Standard Features. Grommets Match Pull Finish - Standard (Unless Specified Otherwise)

Available: - All DARRAN Collections

WIRE MANAGEMENT

BLACK PLASTIC VERTICAL SURFACE GROMMETS - FACTORY INSTALLED



STYLE NUMBER	LIST PRICE	SPECIFICATIONS
<i>Standard Location Grommet</i>		- 2 " Black Plastic Grommet
TM50-C	45	Notes - Standard Location is Bottom Center
<i>Non-Standard Location Grommet</i>		
TM50-NS	90	

Available: - All DARRAN Collections

WORKSTATION

CLIENT PULLOUT WRITING SHELF

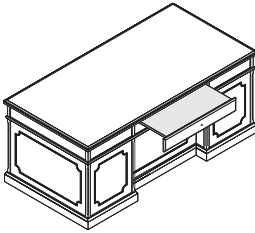

STYLE NUMBER	LIST PRICE	SPECIFICATIONS
CP-1	425	- CP-1: Client pull-out writing shelf for executive chassis desk
CP-2	625	- CP-2: Client pull-out writing shelf for conference desk

Available: - Jamestown

AIRCHARGE WIRELESS CHARGING GROMMET

STYLE NUMBER	LIST PRICE
 ACWG WIRELESS GROMMET	\$575
ACWR WIRELESS RECEIVER W/ LIGHTNING CABLE	\$170



SPECIFICATIONS

- AirCharge offers a convenient way to charge any Qi compatible smartphone or device without the need to carry charging cables or find an available power outlet. Devices not equipped with the Qi technology, can be adapted to accept a charge from the grommet with the AirCharge Wireless Receiver.
- Size: 3.33”DIA x .75”D
- Compatible with an Qi rated device, Contact Customer Service for compatibility list
- Non-Qi device can be adapted to accept AirCharge unit with an ACWR AirCharge Wireless Receiver (compatible with iPhone)
- Surface Mount
- 78” Cord
- Standard Black Aluminum Finish; Available in White Aluminum or Black Finish upon request

AirCharge Wireless Grommet



iphone w/ ACWR



Black Aluminum



Black Finish



White Aluminum

COVE POWER UNIT - NON-LINKING

STYLE NUMBER	LIST PRICE
 PD COVE PLUG Non-Linking Version	\$550

SPECIFICATIONS

- Size 5.75" L x 2.5" W
- (2) 15 Amp Receptacles and (2) USB charging ports
- Surface Mount
- 108" Cord
- Standard Silver Finish, Available in White or Black Finish upon request
- ETL Listed

AVAILABLE

- All Darran Collections



COVE POWER UNIT WITH DAISYLINK

STYLE NUMBER

LIST PRICE

STARTER UNITS



COV-DCH HARDWIRED

\$710

Includes (1) Cove unit with Hardwire Infeed - 120"



COV-DCP PLUG

\$800

Includes (1) Cove unit with Plug infeed - Includes 72" Cord and 32" Infeed Jumper for 104" total cord infeed

ADDITIONAL LINKING UNITS

COV-DCL

\$575 EACH

Includes Linking Cove unit and Jumper up to 96", cable length determined by the top size

SPECIFICATIONS

- Size: 5.75" L x 2.5" W
- (2) 15 Amp Receptacles and (2) 2.1 Amp USB charging ports
- Surface Mount
- Max Daisy Chain - Hardwire - (9) units; Plug/Corded - (4) units
- Standard Silver Finish, Available in White or Black Finish upon request
- ETL Listed

AVAILABLE

- All Darran Collections



COVE CORDED SERIES

STYLE NUMBER	LIST PRICE
 PD-COVE-PKO	\$800

**SPECIFICATIONS**

- Size 9.5" L x 2.5" W x 3.18" D
- (2) Power Receptacles, (2) 2.1 Amp USB charging ports and (1) Telecom Plate Knockout
- Surface Mount
- 108" Cord
- Standard Silver Finish, Available in White or Black Finish upon request
- ETL Listed

AVAILABLE



- All Darran Collections

TELECOM PLATES

THIS POD CAN HAVE UP TO 1 TOTAL PLATES

STYLE NUMBER	LIST PRICE
RJ45 (1)	\$35
RJ45 (2)	\$70
RJ45 (3)	\$105
USB (1)	\$70
USB (2)	\$140
RJ11/RJ45	\$70
RJ45/USB	\$105
RJ45/HDMI	\$190
HDMI/DVI	\$325
HDMI/USB	\$205
HDMI/VGA	\$240
VGA/MINI-STEREO	\$155
VGA/USB	\$175

PDFAA FLUSH DATA BAY ANODIZED ALUMINUM DOOR

	STYLE NUMBER	LIST PRICE
	PDFAA-H Hardwired	\$1195
	PDFAA-C Plug	\$1195
	PDFAA-DC Daisy Chain	\$1395

Features convenience plug on bottom - Max Daisy chain (4) units
 - Specify hardwired or plug for the first unit in series, daisy chained units will have a plug for connection through convenience plug.

SPECIFICATIONS

- Size 13.75"L x 6.375"W x 2.85"D
- (4) 15 Amp receptacles
- Surface Mount
- Standard Interior Black Finish
- Specify up to (4) Telecom Plates; (2) on side and (2) on bottom
- Coded units are UL Listed and CSA Certified. Hardwired Units are CSA Certified



AVAILABLE



- All Darran Collections
- Excludes Rail, Grove

TELECOM PLATES

THIS POD CAN HAVE UP TO 4 TOTAL PLATES

STYLE NUMBER	LIST PRICE
RJ45 (1)	\$35
RJ45 (2)	\$70
RJ45 (3)	\$105
USB (1)	\$70
USB (2)	\$140
RJ11/RJ45	\$70
RJ45/USB	\$105
RJ45/HDMI	\$190
HDMI/DVI	\$325
HDMI/USB	\$205
HDMI/VGA	\$240
VGA/MINI-STEREO	\$155
VGA/USB	\$175

PDFAF FLUSH DATA BAY FROSTED GLASS DOOR WITH DAISYLINK

STYLE NUMBER	LIST PRICE
 PDFAF-H HARDWIRED	\$1095
 PDFAF-C PLUG	\$1095
 PDFAF-DC DAISY CHAIN	\$1295

Features convenience plug on bottom - Max Daisy chain (4) units
 - Specify hardwired or plug for the first unit in series, daisy chained units will have a plug for connection through convenience plug.



SPECIFICATIONS

- Size 13.75"L x 6.375"W x 2.85"D
- (4) 15 Amp receptacles
- Surface Mount
- Standard Interior Black Finish
- Specify up to (4) Telecom Plates; (2) on side and (2) on bottom
- Corded units are UL Listed and CSA Certified. Hardwired Units are CSA Certified

AVAILABLE

- All Darran Collections
- Excludes Rail, Grove



TELECOM PLATES

THIS POD CAN HAVE UP TO 4 TOTAL PLATES

STYLE NUMBER	LIST PRICE
RJ45 (1)	\$35
RJ45 (2)	\$70
RJ45 (3)	\$105
USB (1)	\$70
USB (2)	\$140
RJ11/RJ45	\$70
RJ45/USB	\$105
RJ45/HDMI	\$190
HDMI/DVI	\$325
HDMI/USB	\$205
HDMI/VGA	\$240
VGA/MINI-STEREO	\$155
VGA/USB	\$175

REEF POWER UNIT WITH DAISYLINK

STYLE NUMBER

LIST PRICE



REF310 PLUG

\$1100

SPECIFICATIONS

- Size 16.1”L x 6.25”W x 4.89”D
- (3) 120V Receptacles, (2) USB charging ports and (2) Knockouts for RJ45 Data Ports
- Surface Mount
- 108” Cord
- Features Convenience Plug on bottom of unit that allows for max (3) Daisy Chain
- Standard Black Finish, Available in White or Silver Finish upon request
- Additional Telecom Plate Knockout
- When used with Grove Tables an additional \$350 LIST will apply for the special cutout required.
- RJ45 for Knockouts not required. If not ordered a small hole will be present in the pod in this this location
- ETL Listed

AVAILABLE

- Grove
- Conferencing



TELECOM PLATES

THIS POD CAN HAVE UP TO 1 TOTAL PLATES

STYLE NUMBER	LIST PRICE
RJ45 (1)	\$35
RJ45 (2)	\$70
RJ45 (3)	\$105
USB (1)	\$70
USB (2)	\$140
RJ11/RJ45	\$70
RJ45/USB	\$105
RJ45/HDMI	\$190
HDMI/DVI	\$325
HDMI/USB	\$205
HDMI/VGA	\$240
VGA/MINI-STEREO	\$155
VGA/USB	\$175



SECLUSION CORDED POWER UNIT NON-LINKING

STYLE NUMBER

LIST PRICE



P2SECL

\$245

Choose from plate mount or clamp mount (seen in photo)

SPECIFICATIONS

- Size: 3.5"L x 2.2"D x 2.5"H
- (2) Power Receptacles
- Worksurface Clamp Mount or Plate Under Surface Mount
- Clamp Accessory accommodates table thickness up to 2"
- 72" Cord
- Standard Silver Finish, Black Finish available upon request
- UL/UCL Listed

AVAILABLE

- All Darran Collections



Clamp Mount

UDT POWER UNIT - NON-LINKING

STYLE NUMBER	LIST PRICE
 UDT2/VD-SM PLUG Non-Linking	\$350



SPECIFICATIONS

- Size 6.5"L x 2.81"D x 1.26"H
- (2) Power receptacles and (1) Telecom Plate Cutout
- Side Mount, if Top Mount is required contact customer service
- 72" Cord
- Standard Black Powdercoat Finish
- Used in Apron Rails
- UL Listed

AVAILABLE

- Conferencing Apron Rails

TELECOM PLATES

THIS POD CAN HAVE UP TO 1 TOTAL PLATES

STYLE NUMBER	LIST PRICE
RJ45 (1)	\$35
RJ45 (2)	\$70
RJ45 (3)	\$105
USB (1)	\$70
USB (2)	\$140
RJ11/RJ45	\$70
RJ45/USB	\$105
RJ45/HDMI	\$190
HDMI/DVI	\$325
HDMI/USB	\$205
HDMI/VGA	\$240
VGA/MINI-STEREO	\$155
VGA/USB	\$175

VILLA POWER UNIT - NON-LINKING

STYLE NUMBER	LIST PRICE
 VIL-C PLUG Non-Linking	\$515

SPECIFICATIONS

- Size: Top Grommet 5.68"L X 3.39"W; Under Top 12"L x 3.13"W x 3.08"D
- (2) Power receptacles; (2) USB charging ports and (1) Knockouts for RJ45 Data Ports
- Surface Mount
- 72" Cord (Longer cord available, contact Customer Service)
- Standard Silver Finish, Black Finish available upon request
- UL or ETL Certified

AVAILABLE

- All Darran Collections
- Excludes Grove

RJ45 KNOCKOUT

STYLE NUMBER	LIST PRICE
RJ45 (1)	\$35



VILLA POWER UNIT WITH DAISYLINK

STYLE NUMBER LIST PRICE

STARTER UNITS



VIL-DCH HARDWIRED \$600
Includes (1) Villa unit with 120" Hardwire Infeed



VIL-DCP PLUG \$695
Includes (1) Villa with Plug Infeed - Includes 72" Cord and 32" Infeed Jumper for 104" total cord infeed

ADDITIONAL LINKING UNITS

VIL-DCL ADDITIONAL \$590
(Includes linking Villa and Jumper cable up to 96")



SPECIFICATIONS

- Size: Top Grommet 5.68" L X 3.39"W; Under Top 12"L x 3.13"W x 3.08"D
- (4) Power receptacles; (2) surface and (2) undersurface, (2) 2.1A USB charging ports and (1) Knockout for RJ45 Data Port
- Surface Mount
- Daisy Chain - Hardwire Max (10) Units, Plug/Corded Max (5) Units
- Standard Silver Finish, Black Finish available upon request
- UL or ETL Certified

AVAILABLE

- All Darran Collections
- Excludes Grove



RJ45 KNOCKOUT

STYLE NUMBER LIST PRICE

RJ45 (1) \$35